

Seem[®] 4 Drywall/Hard Ceiling

LED



trimless mud-in



trim flange



regress lens



corner detail



wall to ceiling companion



grid ceiling companion

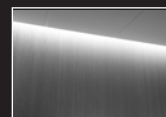

perimeter companion



suspended companion

DIMENSIONAL DATA

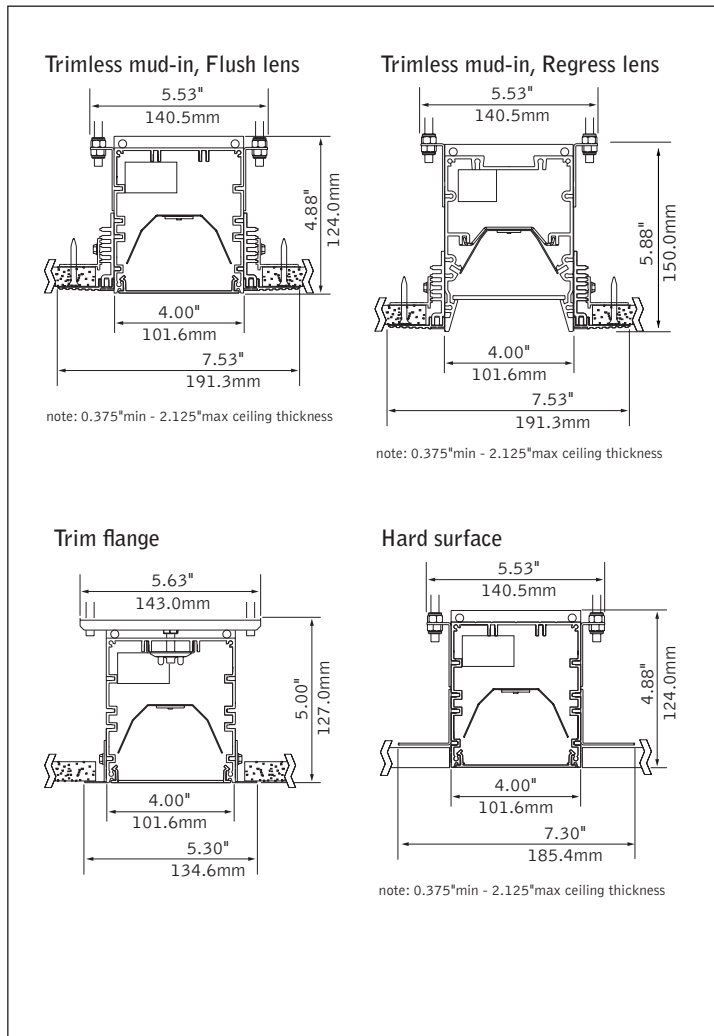

FEATURES

Extruded aluminum 4" aperture recessed slot LED integrates with drywall or hard ceilings or walls in a variety of mounting styles for a clean, unobtrusive aesthetic.

Individual units and continuous runs in 1" increments.

Frosted acrylic lens provides uninterrupted illumination, without pixels or shadows.

LED position and lens material optimized to provide the perfect blend of high performance and visual comfort.

Preferred Light: Lighting for better color rendition and human preference.

PoE compatible: Integrates with Power over Ethernet lighting systems via standard, low-voltage wires.

PERFORMANCE

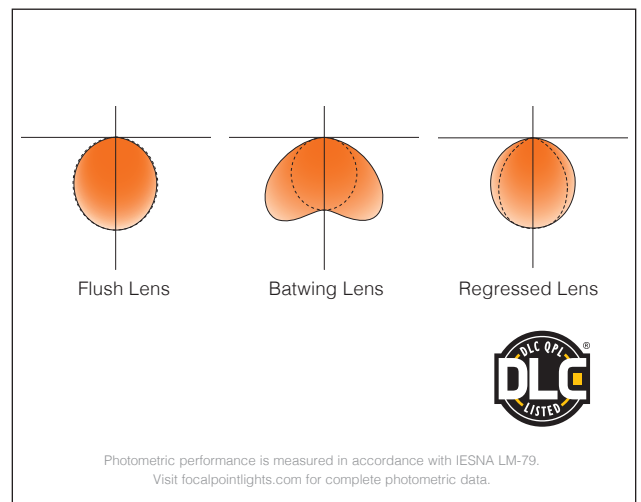

fixture:

project:

DETAILS

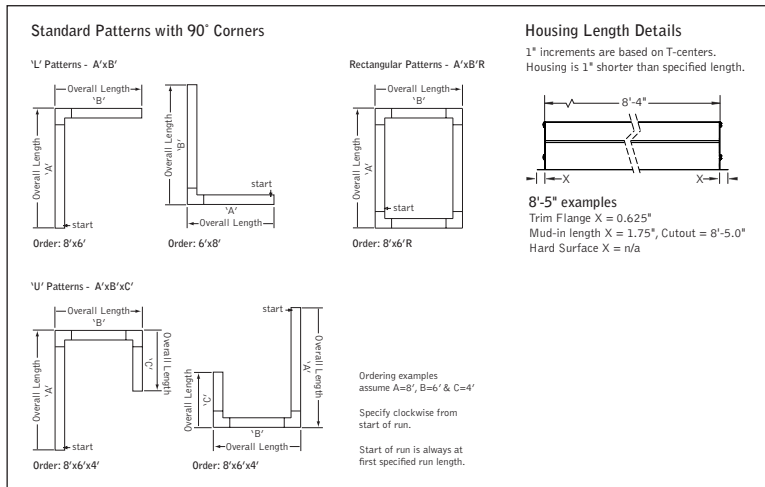

SPECIFICATIONS

LED System

Proprietary linear LED module incorporates premium LEDs on a robust platform to achieve excellent thermal management. LEDs are placed to promote a uniform appearance. Available in 2700K, 3000K, 3500K or 4000K with CRI>80 or CRI>90, 3 SDCM. 3500K and 4000K with CRI>90 have a cyanosis observation index (COI) of 3.3 or less. LED modules and drivers are replaceable from below.

Construction

One piece extruded aluminum housing. 20 Ga. steel end caps. Housing for new construction applications. XFW acceptable for use with wood, consult factory for Type IC availability. 2' unit weight: 12 lbs., 3' unit weight: 16 lbs., 4' unit weight: 20 lbs., 5' unit weight: 24 lbs.

Optic

Reflectors fabricated of 22 Ga. steel finished in High Reflectance White powder coat. Extruded acrylic lens .085" thick with satin finish, up to 8' continuous.

Electrical

Luminaires are pre-wired with factory installed branch circuit wiring and over-molded quick connects. Standard 120-277V constant current driver includes 0-10V analog dimming. Power factor >.9. PoE compatible: Integrates with Power over Ethernet lighting systems via standard, low-voltage wires. PoE runs require an independent PoE node and power feed for each luminaire section.

Emergency

Output - 10 watts for 90 minutes. Maximum mounting height: 19.2ft. See EM/EC Guide for default locations and ordering details.

Labels

UL and cUL listed. Suitable for Dry or Damp Locations, indoor use only.

Finish

Polyester powder coat applied over a multi-stage pre-treatment.

Lumen Maintenance

Reported: L70 > 61,000 hours Calculated: L70 at > 480,000 hours
 L90 > 61,000 hours L90 at > 128,000 hours
 (Derived from EPA T M-21 calculator. Based on typical conditions, consult factory for additional data.)

Reliability

At Focal Point, our products are designed to stand the test of time. Each luminaire is engineered using superior components, manufactured with the utmost care and rigorously tested. Contact us for reliability data.

Warranty

LED system rated for operation in ambient environments up to 25°C. 5-year limited warranty.

4' PERFORMANCE CHART

See page 3.

ORDERING

Luminaire Series

Seem 4 LED **FSM4L**

Shielding

Batwing Lens **BW**

Flush Satin Lens **FL**

Regress Lens **SR**

(Ceiling applications only)

Regress High Performance Lens **SRXP**

(Ceiling applications only)

Lumen Output

275 Lumens per foot **275LF**

(Not available with Lutron Drivers.)

375 Lumens per foot **375LF**

(Not available with LU5 & LH1 Drivers)

625 Lumens per foot **625LF**

(BW, FL & SR 3' minimum with LU5 & LH1 Drivers. SRXP 4' minimum with LU5 & LH1 Drivers.)

875 Lumens per foot **875LF**

(SR & SRXP 3' minimum with LU5 & LH1 Drivers)

1000 Lumens per foot **1000LF**

1125 Lumens per foot **1125LF**

1250 Lumens per foot **1250LF**

Color Temperature

2700K, 80+ CRI or 90+ CRI **27K or 927K**

3000K, 80+ CRI or 90+ CRI **30K or 930K**

3500K, 80+ CRI or 90+ CRI **35K or 935K**

4000K, 80+ CRI or 90+ CRI **40K or 940K**

3500K, Preferred Light **P35K**

(BW & FL Lens only. 6" increments. Patterns not available.)

Circuit

Single Circuit **1C**

Voltage

UNV 120/277 Volt **UNV**

Low Voltage **LV**

Control System & Dimming Level

0-10V - 10% Dimming **LD1**

0-10V - 1% Dimming **L11**

Low Voltage, PoE compatible **LVN**

(No driver. Not available with EM or EC. LV Voltage only.)

Lutron Hi-Lume EcoSystem (LDE1) -

1% Dimming **LH1**

Lutron 5-Series EcoSystem (LDE5) -

5% Dimming **LU5**

DALI 1% Dimming (1000LF max.) **D11**

Ceiling Configuration

Trim Flange Drywall **TF**

(3' minimum with Lutron Drivers)

Trim Flange Wood **TFW**

(3' minimum with Lutron Drivers)

Mud-in Trimless, pre-set for 1/2" Drywall **XF1**

Mud-in Trimless, pre-set for 5/8" Drywall **XF2**

Mud-in Trimless, set thickness in field **XFF**

(Mounting equipment assembled in field)

Non-Drywall Hard Surface **XFN**

Hard Surface, Wood **XFW**

Factory Options

Chicago Plenum **CP**

Emergency Circuit **_EC**

(4' minimum.)

Emergency Battery Pack **_EM**

(4' minimum. Not available at corners. See EM/EC Guide for default locations and ordering details.)

6' New York City Flex Whip (120V) **FNY1**

6' New York City Flex Whip (277V) **FNY2**

6' Flex Whip **FW**

Finish

Matte White Housing **WH**

Luminaire Length

Specify luminaire/row **_ft _in**

length in 1" increments

(2' minimum, lengths are nominal 1" increments based on T-centers. Housing length is 1" shorter than specified. Leave blank for patterns. Smaller increments available, consult factory.)

Pattern Options

(3' minimum length)

'L' pattern **A' x B'**

'U' pattern **A' x B' x C'**



Rectangular pattern **A' x B' R**

(Consult factory for other pattern options)





Options in orange qualify for the Quickship program. 1000' total, 48' maximum per pattern section. Refer to Quickship Guide for complete details including EM/EC options.

4' PERFORMANCE CHART

Lumens Output	Delivered Lumens	Tested System Watts	LPW	
			 BW	 FL
275	1100	10	104	100
375	1500	13	113	108
625	2500	22	112	107
875	3500	32	109	105
1000	4000	37	109	104
1125	4500	44	108	104
1250	5000	49	107	102

Based on 3500K, 80 CRI, 4' lengths. Lumen multipliers: Preferred Light = 0.65, 90+ CRI = 0.87.
Lumen output may vary +/- 5%. Actual wattage may vary +/- 5%.

4' PERFORMANCE CHART - REGRESS

Lumens Output	Delivered Lumens	Tested System Watts	LPW	
			 SR	 SRXP
275	1100	12	79	98
375	1500	16	84	109
625	2500	26	84	110
875	3500	39	80	105
1000	4000	46	77	101
1125	4500	53	76	101
1250	5000	59	75	99

Based on 3500K, 80 CRI, 4' lengths. Lumen multipliers: Preferred Light = 0.65, 90+ CRI = 0.87.
Lumen output may vary +/- 5%. Actual wattage may vary +/- 5%.