

0.5"
pop-down lens



1.5"
pop-down lens



end
detail

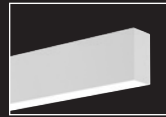

wall mount
companion



recessed
companion

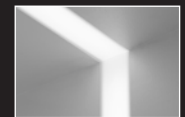

wall to ceiling
companion

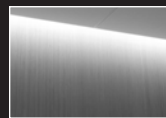

perimeter
companion



direct/indirect
companion

DIMENSIONAL DATA

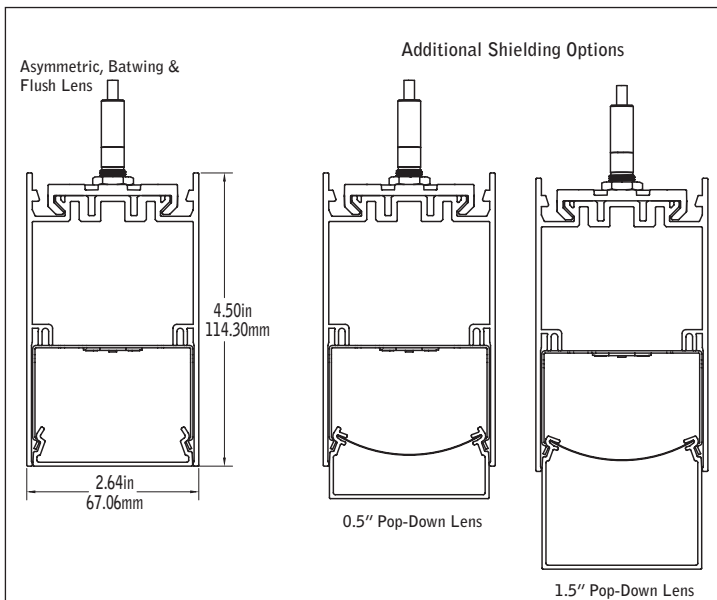

MOUNTING INFORMATION

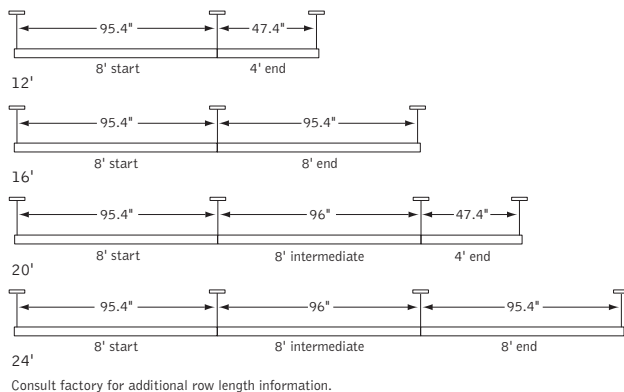

FEATURES

Narrow 2.5" linear direct LED with Asymmetric, Batwing, Flush, 0.5" or 1.5" Pop-Down lens.

Frosted acrylic lens provides uninterrupted illumination, without pixels or shadows.

Individual units and continuous runs in 1' increments.

Preferred Light: Lighting for better color rendition and human preference.

Connected Solutions: Integrates with wired and wireless building lighting control systems.

PoE compatible: Integrates with Power over Ethernet lighting systems via standard, low-voltage wires.

DISTRIBUTIONS

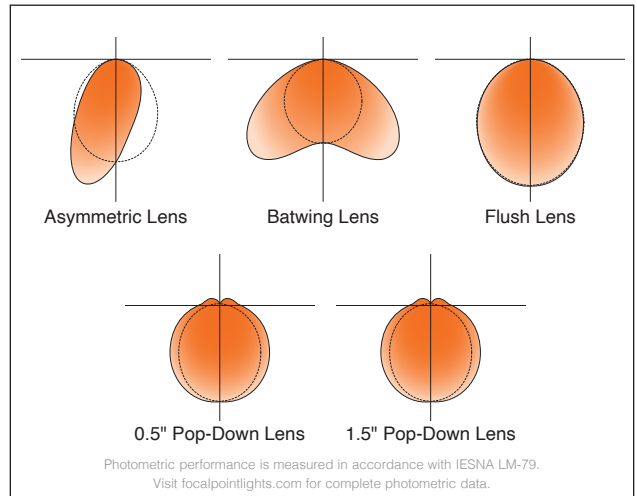

MOUNTING INFORMATION

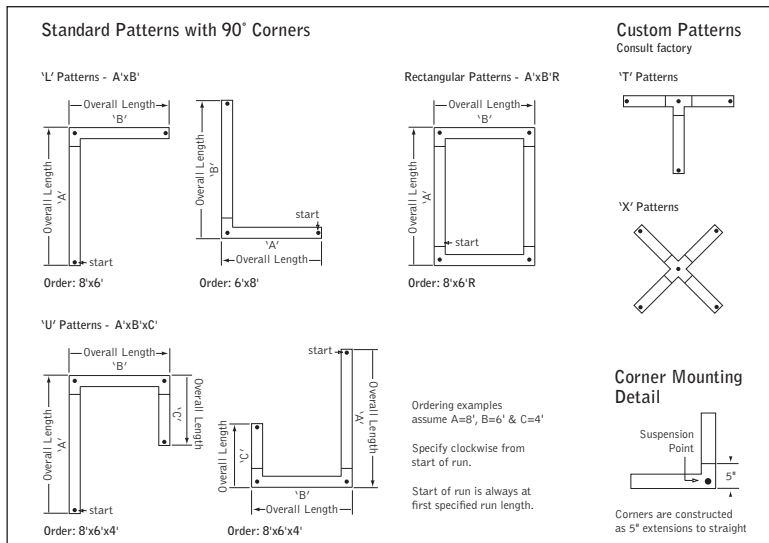

SPECIFICATIONS

LED System

Proprietary linear LED module incorporates premium LEDs on a robust platform to achieve excellent thermal management. LEDs are placed to promote a uniform appearance. Available in 2700K, 3000K, 3500K or 4000K with CRI>80 or CRI>90, 3 SDCM. 3500K and 4000K with CRI>90 have a cyanosis observation index (COI) of 3.3 or less. LED modules and drivers are replaceable from below.

Construction

One piece extruded aluminum housing. Cast aluminum end caps. 8' unit weight: 30 lbs.

Optic

Reflectors fabricated of 22 Ga. steel finished in matte white powder coat. Extruded acrylic lens with satin finish, up to 8' continuous.

Electrical

Luminaires are pre-wired with factory installed branch circuit wiring and over-molded quick connects. Standard 120-277V constant current driver includes 0-10V analog dimming. Power factor > .90. PoE compatible: Integrates with Power over Ethernet lighting systems via standard, low-voltage wires. PoE runs require an independent PoE node and power feed for each luminaire section.

Emergency

Emergency Battery output - 10 watts for 90 minutes. Maximum mounting height: 20 ft. Emergency Circuit with Connected Solutions (NLT1, ENL1, CLM1, CLMZ1, DLM1) shipped standard with leads to connect UL924 compliant device, by others. See EM/EC Guide for default locations and ordering details.

Labels

UL and cUL listed. Suitable for Dry or Damp Locations, indoor use only.

Finish

Polyester powder coat applied over a multi-stage pre-treatment. Canopy and cord white as standard.

Lumen Maintenance

Reported: L70 at >61,000 hours Calculated: L70 at 385,000 hours
 L90 at >61,000 hours L90 at 103,000 hours

Derived from EPA TM-21 calculator. Based on typical conditions, consult factory for additional data.

Reliability

At Focal Point, our products are designed to stand the test of time. Each luminaire is engineered using superior components, manufactured with the utmost care and rigorously tested. Contact us for reliability data.

Warranty

LED system rated for operation in ambient environments up to 25°C. 5-year limited warranty.

4' PERFORMANCE CHART





See page 3.

ORDERING

Luminaire Series	FSM2LS
Seem 2 LED	FSM2LS
Shielding	
Asymmetric Lens	AS
Batwing Lens	BW
Flush Satin Lens	FL
0.5" Pop-Down Lens	PD05
1.5" Pop-Down Lens (Individual units only)	PD15
Lumen Output	
125 Lumens per foot (LD1 & L11 only, 4' minimum.)	125LF
250 Lumens per foot (3' minimum with LU5, LH1)	250LF
375 Lumens per foot	375LF
500 Lumens per foot	500LF
625 Lumens per foot	625LF
750 Lumens per foot	750LF
875 Lumens per foot	875LF
1000 Lumens per foot	1000LF
Color Temperature	
2700K, 80+ CRI or 90+ CRI	27K or 927K
3000K, 80+ CRI or 90+ CRI	30K or 930K
3500K, 80+ CRI or 90+ CRI	35K or 935K
4000K, 80+ CRI or 90+ CRI	40K or 940K
3500K, Preferred Light (Not available with EM)	P35K
Circuit	1C
Single Circuit	1C
Voltage	
UNV 120/277 Volt	UNV
347V (LD1 & L11 only)	347
Low voltage	LV
Control System & Dimming Level	
0-10V - 10% Dimming	LD1
0-10V - 1% Dimming	L11
Low-voltage, PoE compatible (No driver. Not available with EM or EC. LV Voltage only.)	LVN
Lutron Hi-Lume EcoSystem (LDE1) - 1% Dimming	LH1
Lutron 5-Series EcoSystem (LDE5) - 5% Dimming	LU5
DALI - 1% Dimming (For 750LF, 875LF & 1000LF consult factory.)	D11
Acuity nLight - 1% Dimming** (3' minimum length. Individual units only. For 750LF, 875LF & 1000LF consult factory.)	NLT1
Enlighted Smart Sensor - 1% Dimming* (3' minimum length)	ENL1
Osram Connected Lighting Module for ENCELIIUM systems - 1% Dimming** (3' minimum length. Compatible with Osram ENCELIIUM and ENCELIIUM EDGE systems only)	CLM1
Osram Connected Lighting Module for ZigBee Wireless Networks - 1% Dimming** (3' minimum length. Not compatible with Osram ENCELIIUM systems)	CLMZ1
Wattstopper DLM - 1% Dimming** (3' minimum length, Individual units only.)	DLM1
Mounting	
24" Cable Suspension	C24__
48" Cable Suspension	C48__
96" Cable Suspension (Specify canopy color White (WH), Black (BK) or Titanium Silver (TS). Example: C24WH.) (Specify one of the following in place of "C" J - for 2' canopies at non-feed locations. CS - for sloped ceiling applications.)	C96__
Surface Mount (Not available with CLM1, CLMZ1, DLM1 or NLT1)	SM
Factory Options	
Black Cord	BKCD
Emergency Circuit	_EC
Emergency Battery Pack (3' minimum. 120/277 Volt only. 4' minimum with CLM1, CLMZ1, DLM1, ENL1, & NLT1. See EM/EC Guide for default locations and ordering details.)	_EM
Finish	
Black	BK
Titanium Silver	TS
Matte White Housing	WH
Luminaire Length	
Specify luminaire/row length in 1' increments (2' minimum. Leave blank for patterns. Smaller increments available, consult factory.)	X'
Pattern Options	
(2' minimum length)	
'L' pattern	A' x B'
'U' pattern	A' x B' x C'
Rectangular pattern (Consult factory for other pattern options)	A' x B' R

QS 10 DAY Options in orange qualify for the Quickship program. 1000' total. Refer to Quickship Guide for complete details including EM/EC options.

4' PERFORMANCE CHART

Lumen Output	Delivered Lumens	Tested System Watts	Lumens Per Watt (LPW)				
			 AS	 BW	 FL	 PD05	 PD15
125LF	500	6	95	91	88	81	82
250LF	1000	10	113	108	103	94	98
375LF	1500	14	120	116	105	101	100
500LF	2000	19	123	118	107	103	102
625LF	2500	24	121	116	105	101	101
750LF	3000	28	122	117	108	101	100
875LF	3500	34	120	115	104	100	100
1000LF	4000	39	119	114	105	101	100

Based on 3500K, 4' length. Lumen multipliers: Preferred Light = 0.65, 90 CRI = 0.87.
 Delivered lumens may vary +/- 5%. Actual wattage may vary +/- 5%

Focal Point provides flexibility in meeting the needs of each project by integrating with several building lighting control systems. A variety of sensors, drivers and other components can be specified that allow the luminaires to communicate with wired and wireless networks. All zoning can be digitally reconfigured through the application software. Daylight harvesting, occupancy sensing, integration with HVAC systems, and individual controls enable the monitoring and modulating of light levels and temperature in order to save energy, reduce costs and maximize occupants' comfort. All Connected Solutions luminaires require a compatible building control system.†

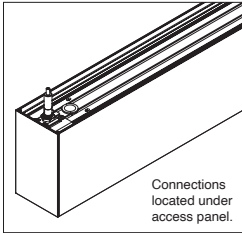

nLight[®] provides a two-way wired digital lighting system allowing for on/off and dimming functionality, occupancy sensing, and multi-zone daylight harvesting.

Acuity nLight - 1% Dimming (NLT1)
Acuity Model #nEPS-60-IO

CAT-5 Cable provided by others. Serial labels will be provided on outside of luminaires and control unit.

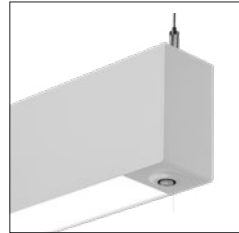

Enlighted smart sensor allows for occupancy sensing, daylight harvesting, energy usage, temperature and light level control. Communicates wirelessly with the Enlighted network.

Enlighted Smart Sensor - 1% Dimming (ENL1)
Enlighted Model SU-5E-IOT

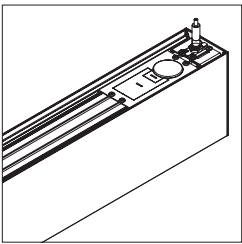
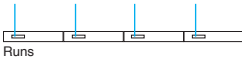

Connected Lighting Module (CLM) enables each luminaire to be independently controlled and configured. Communicates wirelessly with Daintree Networks[®], Osram ENCELIUM[®], Osram ENCELIUM EDGE[™], and other networks using the ZigBee[®] HA communication protocol to allow for on/off and dimming functionality, occupancy sensing and multi-zone daylight harvesting.

Osram CLM - 1% Dimming (CLM1 & CLMZ1)
Osram Model #ZBHA-CLM DIM

Serial labels will be provided on outside of luminaires and control unit.

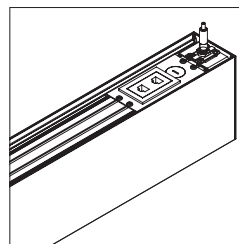

A Digital Lighting Management (DLM) system that provides two-way wired communication between networked luminaires and control system to allow for on/off and dimming functionality, occupancy sensing and multi-zone daylight harvesting.

Wattstopper DLM - 1% Dimming (DLM1)
Wattstopper Model #LMFC-011

Segment Network Wire provided by others. Serial labels will be provided on outside of luminaires and control unit.

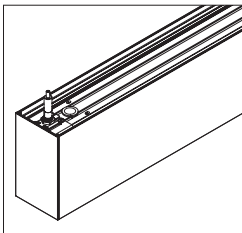
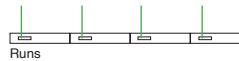

A two-way digital network that enables on/off and dimming functionality, occupancy sensing, and multi-zone daylight harvesting working with Quantum[®], Energi Savr Node[™], and Energi TriPak[®] using EcoSystem[®] communication protocol.

Lutron Hi-Lume EcoSystem - 1% Dimming (LH1)
Lutron Model #LDE1
Lutron 5-Series EcoSystem - 5% Dimming (LU5)
Lutron Model #LDE5

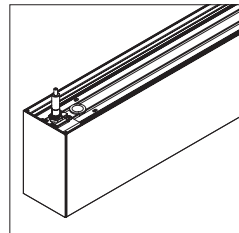

A two-way digital network that enables on/off and dimming functionality, occupancy sensing, and multi-zone daylight harvesting. Communicates with Züm wireless and SpaceBuilder working with Züm hub scheduling or FUSION management.

DALI - 1% Dimming (D11)
0-10V - 1% Dimming (L11)

Note: 0-10V is not a digital network but is compatible with Creston Züm[™] system.

CONNECTED SOLUTIONS DETAILS

Connected Solution	Model #	Protocol	Compatible Networks*	Occupancy	Daylight	Temperature Reporting	Communication to Luminaire	Drivers
Acuity nLight (NLT1)	nEPS-60-IO**	nLight	nLight	Enabled	Enabled	No	Wired	eldoLED ECOdrive , eldoLED SOLOdrive
Crestron (D11, L11)	Specified Driver	DALI 0-10V	Crestron Züm Wireless & SpaceBuilder	Enabled	Enabled	No	Wired	eldoLED ECOdrive (DALI) , Advance by Signify
Enlighted Smart Sensor (ENL1)	SU-5E-IOT**	Enlighted RF	Enlighted	Integrated	Integrated	Yes	Wireless	Advance by Signify , Osram Optotronic
Legrand Wattstopper DLM (DLM1)	LMFC-011**	DLM	DLM	Enabled	Enabled	No	Wired	Advance by Signify , Osram Optotronic
Lutron EcoSystem (LH1 & LU5)	LDE1** LDE5**	EcoSystem	Quantum, Energi Savr Node, Energi TriPak	Enabled	Enabled	No	Wired	Lutron Hi-Lume Lutron 5-Series
Osram CLM for ENCELIUM systems (CLM1)	ZBHA-CLM**	ZigBee HA	Osram ENCELIUM & ENCELIUM EDGE	Enabled	Enabled	No	Wireless	Osram Optotronic
Osram CLM for ZigBee Wireless Networks (CLMZ1)	ZBHA-CLM**	ZigBee HA	Daintree Networks & open ZigBee Networks	Enabled	Enabled	No	Wireless	Osram Optotronic

*Not all compatible networks may be listed. **For performance data and additional control system details please visit the connected solutions manufacturer websites. Primary drivers are listed in bold. To specify a particular driver please consult factory. †Controls systems supplied by others.