

Seem[®] 2

LED INDIRECT ONLY



Wall mount companion



Direct companion



Direct/Indirect companion



Recessed companion

DIMENSIONAL DATA

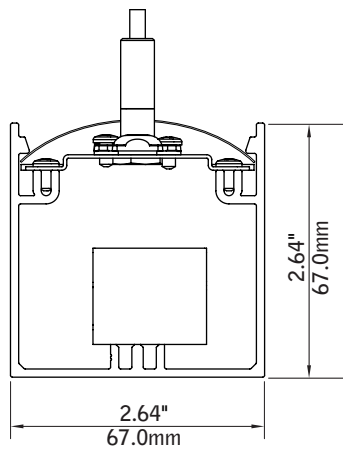

Mounting Information

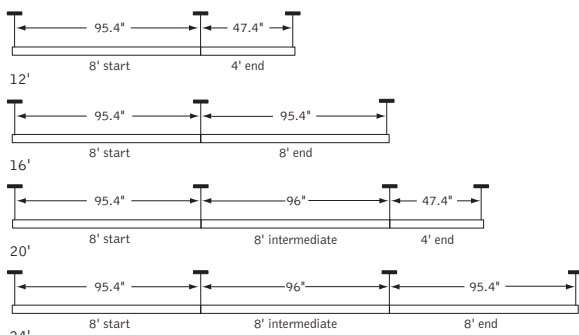

Consult factory for additional row length information.

FEATURES

2.64" square extruded aluminum linear indirect LED suspended luminaire.

Individual units and continuous runs in 1" increments.

Choice of output levels and light distributions to meet a wide variety of application needs.

Features Right Light lumen levels allowing lumen and wattage design flexibility.

Preferred Light: Lighting for better color rendition and human preference.

PoE compatible: Integrates with Power over Ethernet lighting systems via standard, low-voltage wires.

PERFORMANCE

4' Asymmetric Optic 625 Lumens per foot	4' Batwing Optic 625 Lumens per foot	4' Dust Cover 625 Lumens per foot
Total Lumen Output: 2500lm	Total Lumen Output: 2500lm	Total Lumen Output: 2500lm
Total System Watts: 20	Total System Watts: 20	Total System Watts: 20

Photometric performance is measured in accordance with IESNA LM-79. Visit focalpointlights.com for complete photometric data.

MOUNTING INFORMATION

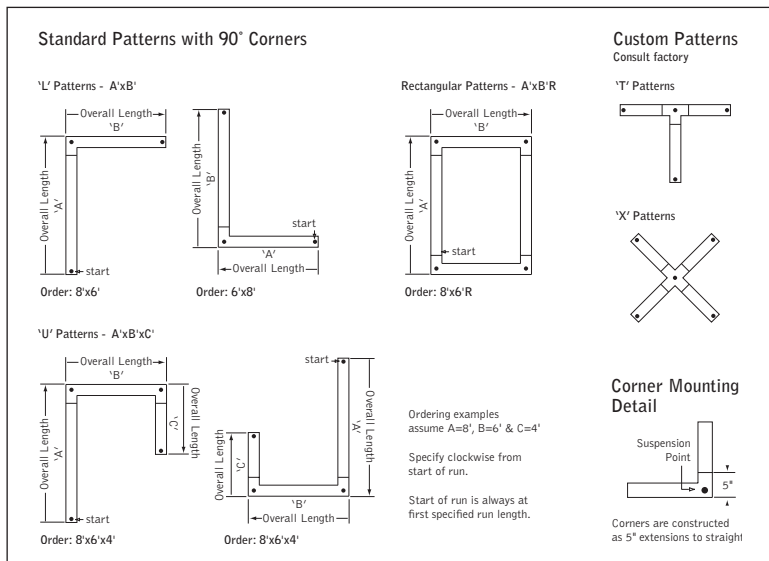

SPECIFICATIONS

LED System

Proprietary linear LED module incorporates premium LEDs on a robust platform to achieve excellent thermal management. LEDs are placed to promote a uniform appearance. Available in 2700K, 3000K, 3500K or 4000K with both 80 and 90 CRI options. 3500K and 4000K with CRI>90 have a cyanosis observation index (COI) of 3.3 or less. LED modules and drivers are replaceable from above. Color accuracy <3 SDCM.

Construction

One piece extruded aluminum housing. Cast aluminum end caps. 8' unit weight: 16lbs.

Optic

Reflectors fabricated of 20 Ga. steel finished in Matte White powder coat.

Electrical

Luminaires are pre-wired with factory installed branch circuit wiring and over-molded quick connects. Standard 120-277V constant current driver includes 0-10V analog dimming. Power factor > .9. PoE compatible: Integrates with Power over Ethernet lighting systems via standard, low-voltage wires. PoE runs require an independent PoE node and power feed for each luminaire section.

Backup Battery / Auxillary Circuit

Backup battery output - 10 watts for 90 minutes. EM/EC options do not meet UL 924 requirements.

Labels

UL and cUL Listed. Suitable for Dry or Damp Locations, indoor use only.

Finish

Polyester powder coat applied over a multi-stage pre-treatment. Canopy and cord white as standard.

Lumen Maintenance

Reported: L70 at >61,000 hours Calculated: L70 at 480,000 hours
 L90 at >61,000 hours L90 at 128,000 hours

Derived from EPA TM-21 calculator. Based on typical conditions, consult factory for additional data.

Reliability

At Focal Point, our products are designed to stand the test of time. Each luminaire is engineered using superior components, manufactured with the utmost care and rigorously tested. Contact us for reliability data.

Warranty

LED system rated for operation in ambient environments up to 25°C. 5-year limited warranty.



4' PERFORMANCE CHART

See page 3.

ORDERING

Luminaire Series		FSM2IS
Seem 2 LED Indirect	FSM2IS	
Shielding		
Asymmetric Optic	AS	
Batwing Optic	BW	
Dust Cover	DC	
Indirect Distribution		
250 Lumens per foot	250LF	
375 Lumens per foot	375LF	
500 Lumens per foot	500LF	
625 Lumens per foot	625LF	
750 Lumens per foot	750LF	
875 Lumens per foot	875LF	
1000 Lumens per foot	1000LF	
1125 Lumens per foot	1125LF	
1250 Lumens per foot	1250LF	
1375 Lumens per foot	1375LF	
1500 Lumens per foot	1500LF	
1625 Lumens per foot	1625LF	
Color Temperature		
2700K, 80+ CRI or 90+ CRI	27K or 927K	
3000K, 80+ CRI or 90+ CRI	30K or 930K	
3500K, 80+ CRI or 90+ CRI	35K or 935K	
4000K, 80+ CRI or 90+ CRI	40K or 940K	
3500K, Preferred Light	P35K	
Circuits & Zones		
1 Circuit, non-emergency	1C	
Consult Ordering Guide on page 4 for multiple circuiting and zoning options	_C_Z_DL	
Voltage		
120/277 UNV Volt	UNV	
347 Volt	347	
(LD1 driver only)		
Low Voltage	LV	
Control System & Dimming Level		
0-10V - 10% Dimming	LD1	
0-10V - 1% Dimming	L11	
Low Voltage, PoE compatible	LVN	
(No driver. Not available with EM or EC. LV Voltage only)		
Lutron Hi-Lume EcoSystem (LDE1) - 1% Dimming	LH1	
DALI 1% Dimming	D11	
(250LF 3' minimum, 875LF max.)		
Mounting		
24" Cable Suspension	C24_	
48" Cable Suspension	C48_	
96" Cable Suspension	C96_	
(Specify canopy color White (WH), Black (BK) or Titanium Silver (TS). Example: C24WH.)		
(Specify one of the following in place of "C"		
J - for 2" canopies at non-feed locations.		
CS - for sloped ceiling applications.)		
Factory Options		
(See Ordering Guide on page 4 for ordering details for DC, EC, EM & ECD.)		
Black Cord	BKCD	
Daylight Circuit	_DC	
Auxillary Circuit	_EC	
Backup Battery Pack†	_EM	
Emergency Control Device†	_ECD	
†(4' minimum, 120/277 Volt only. Does not meet UL 924.)		
Finish		
Black	BK	
Titanium Silver	TS	
Matte White Housing	WH	
Luminaire Length		ft in
Specify luminaire/row length in 1" increments	_ft_in	
(2' minimum length). Smaller increments available, consult factory.)		
Pattern Options		
(2' minimum length)		
'L' pattern	A' x B'	
'U' pattern	A' x B' x C'	
Rectangular pattern	A' x B' R	
(Consult factory for other pattern options)		

SEEM 2 INDIRECT SUSPENDED - 4' PERFORMANCE CHART

Lumens per Foot	Delivered Lumens	Tested System Watts	 Asymmetric Optic	 Batwing Optic	 Dust Cover
			LPW	LPW	LPW
250LF	1000	9	105	107	113
375LF	1500	13	113	116	123
500LF	2000	17	119	122	129
625LF	2500	20	122	125	132
750LF	3000	25	121	124	131
875LF	3500	29	120	123	130
1000LF	4000	33	121	123	130
1125LF	4500	37	121	123	130
1250LF	5000	41	120	123	129
1375LF	5500	45	121	123	130
1500LF	6000	49	121	123	130
1625LF	6500	54	122	124	130

Based on 3500K, 80 CRI, 4' lengths. Lumen multipliers: Preferred Light = 0.65, 90 CRI = 0.87. Lumen output may vary +/- 5%. Actual wattage may vary +/- 5%.

INDIRECT ASYMMETRIC OPTIC

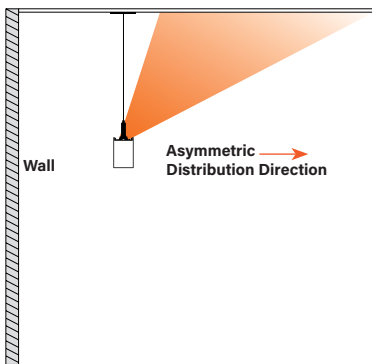

STANDARD APPLICATION EXAMPLE

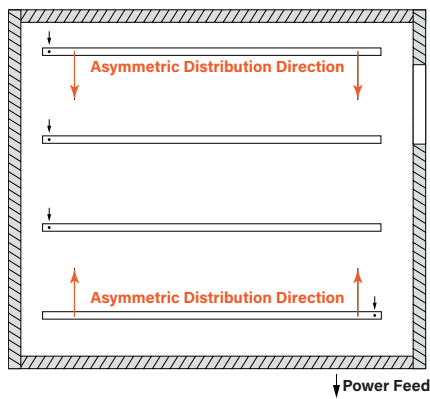

Ordering Guide

Linear Circuitry, Zones & Factory Options

HOW TO USE THIS GUIDE

Fill out the worksheet on the following page to specify your requirements for circuitry, zones, and factory options.

Refer to the run chart for standard run configurations, consult factory for custom configurations.

Complete the Totals / Ordering Codes at the bottom of the worksheet and add to your ordering logic on the cut sheet.

Submit the worksheet along with your order.

TOTAL RUN LENGTH: <u>32ft</u>		JOB NAME: _____			FIXTURE TYPE: _____			
HOUSING SECTION	SECTION LENGTH	SHARED ELECTRICAL FEED, NORMAL POWER			FACTORY OPTIONS			
		SWITCHING CIRCUIT	DIMMING ZONE	DAYLIGHT ZONE	SEPARATE ELECTRICAL FEEDS			EM
					DAYLIGHT CIRCUIT	AUXILLARY CIRCUIT	ECD	
1	8	1C	1Z					1EM
2	8	2C	2Z					
3	8	2C	2Z					
4	8				1DC			
Totals / Ordering Codes		2C	2Z		1DC			1EM

ORDERING: FSM2IS-DC-625LF-35K- **2C2Z** -UNV-LD1-C24WH- **1DC-1EM** -WH-32ft

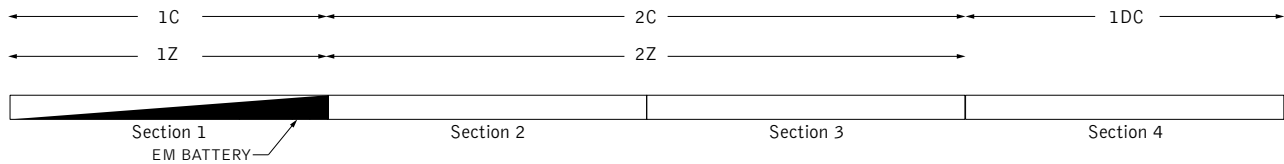

KEY	
C = Switching Circuit Switched Hot / Shared Neutral	DC = Daylight Circuit Switched Hot / Separate Neutral
Z = Dimming Zone Dimming Control Wires	EC = Emergency Circuit Switched Hot / Separate Neutral
DL = Daylight Zone Daylight Dimming Control Wires	EM = Emergency Battery Unswitched Hot / Shared Neutral
	ECD = Emergency Control Device Unswitched Hot / Separate Neutral

DEFAULTS

- Zones and Factory Options illuminate entire sections from 4' to 8' in length.
- One shared or isolated circuit and zone required per housing section.
- Limit of one EM or ECD per housing section.
- Additional electrical feed required for applications greater than three shared circuits and zones.
- Each DC, EC and ECD require an additional electrical feed.
- ECD not available in the same housing section as EC.
- Longer lead times and additional pricing may apply for custom run configurations.

CUSTOM LENGTHS

- If partial illumination of emergency or daylight section is required, indicate in ordering guide and add "partial illumination" in Order Notes. Drawing required.
- Engineering validation required, longer lead times may apply.

Ordering Guide Worksheet

Linear Circuitry, Zones & Factory Options

TOTAL RUN LENGTH: _____		JOB NAME: _____			FIXTURE TYPE: _____			
HOUSING SECTION	SECTION LENGTH	SHARED ELECTRICAL FEED, NORMAL POWER			FACTORY OPTIONS			
		SWITCHING CIRCUIT	DIMMING ZONE	DAYLIGHT ZONE	SEPARATE ELECTRICAL FEEDS			EM
DAYLIGHT CIRCUIT	AUXILLARY CIRCUIT				ECD			
1								
2								
3								
4								
5								
6								
7								
8								
9								
10								
11								
12								
13								
14								
15								
16								
17								
18								
19								
20								
Totals / Ordering Codes								

WORKSHEET

Combine to create Circuits & Zones ordering code

Enter as individual Factory Options

RUN CHART

Run length (ft)	Housing Configuration Section Lengths	Run length (ft)	Housing Configuration Section Lengths	Run length (ft)	Housing Configuration Section Lengths	Run length (ft)	Housing Configuration Section Lengths
9	5 + 4	21	8 + 8 + 5	33	8 + 8 + 8 + 5 + 4	45	8 + 8 + 8 + 8 + 8 + 5
10	6 + 4	22	8 + 8 + 6	34	8 + 8 + 8 + 6 + 4	46	8 + 8 + 8 + 8 + 8 + 6
11	7 + 4	23	8 + 8 + 7	35	8 + 8 + 8 + 7 + 4	47	8 + 8 + 8 + 8 + 8 + 7
12	8 + 4	24	8 + 8 + 8	36	8 + 8 + 8 + 8 + 4	48	8 + 8 + 8 + 8 + 8 + 8
13	8 + 5	25	8 + 8 + 5 + 4	37	8 + 8 + 8 + 8 + 5		
14	8 + 6	26	8 + 8 + 6 + 4	38	8 + 8 + 8 + 8 + 6		
15	8 + 7	27	8 + 8 + 7 + 4	39	8 + 8 + 8 + 8 + 7		
16	8 + 8	28	8 + 8 + 8 + 4	40	8 + 8 + 8 + 8 + 8		
17	8 + 5 + 4	29	8 + 8 + 8 + 5	41	8 + 8 + 8 + 8 + 5 + 4		
18	8 + 6 + 4	30	8 + 8 + 8 + 6	42	8 + 8 + 8 + 8 + 6 + 4		
19	8 + 7 + 4	31	8 + 8 + 8 + 7	43	8 + 8 + 8 + 8 + 7 + 4		
20	8 + 8 + 4	32	8 + 8 + 8 + 8	44	8 + 8 + 8 + 8 + 8 + 4		

Standard run configurations, consult factory for custom configurations.