

Seem® 1 Point Source

LED RECESSED

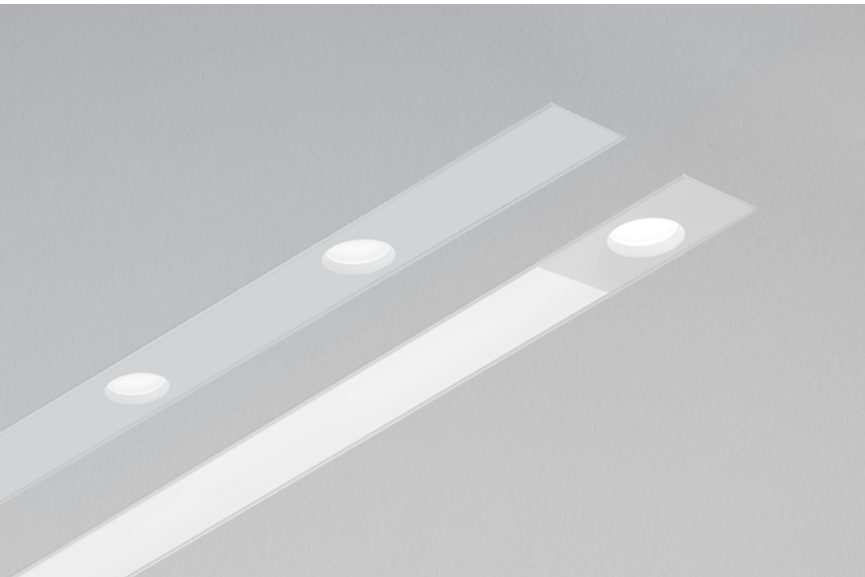

FOCAL POINT®



Intermediate point source detail



Grid ceiling white finish



Grid ceiling black finish



6" spacing



12" spacing



Direct suspended companions



Direct/indirect companions

DIMENSIONAL DATA

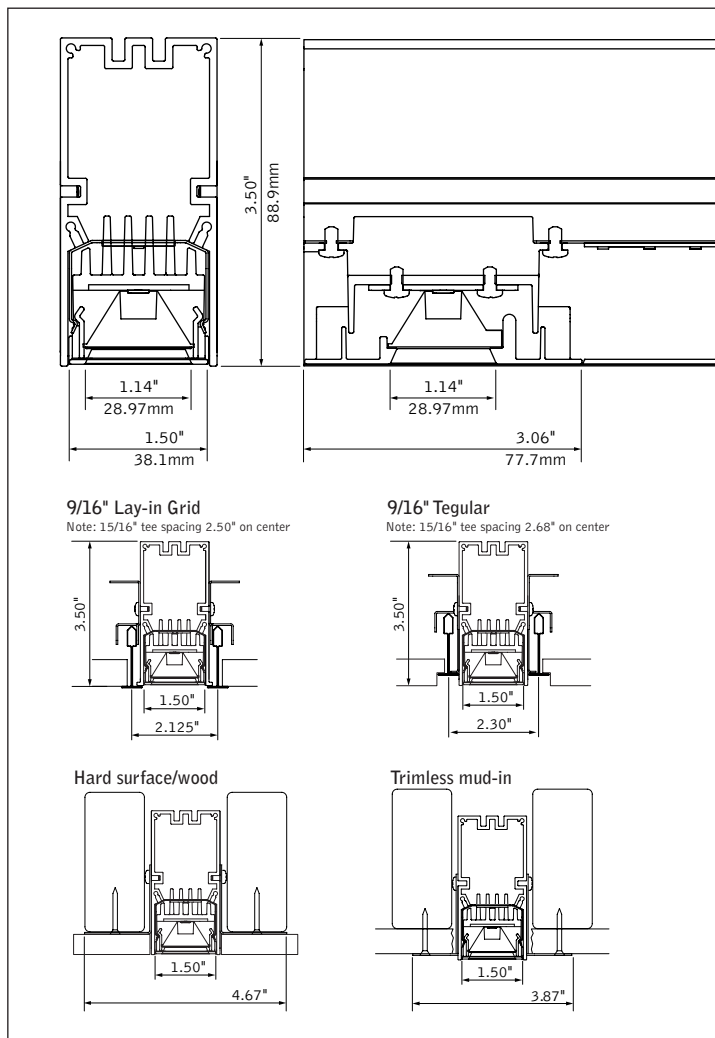

FEATURES

Narrow extruded aluminum nominal 1.5" linear direct illumination with integrated point source downlights.

Individual units and continuous runs in 1' increments.

Frosted acrylic lenses provide uninterrupted illumination, without pixels or shadows.

LED position and lens material optimized to provide the perfect blend of high performance and visual comfort.

Choice of output levels and light distributions to meet a wide variety of application needs.

DISTRIBUTIONS

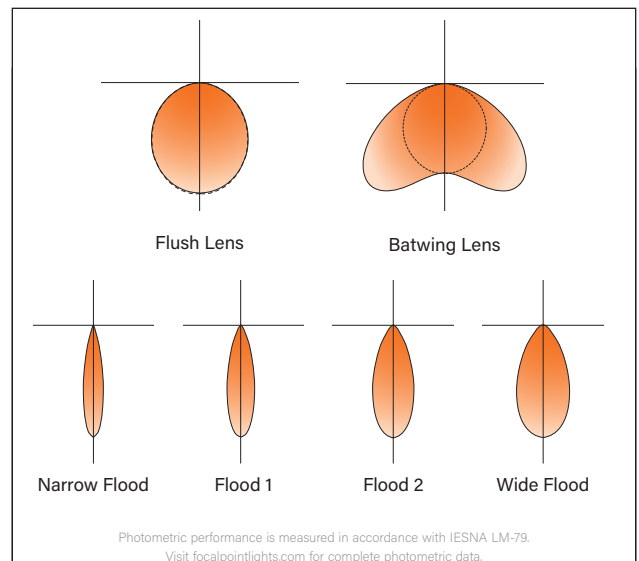

fixture:

project:

POINT SOURCE SPACING

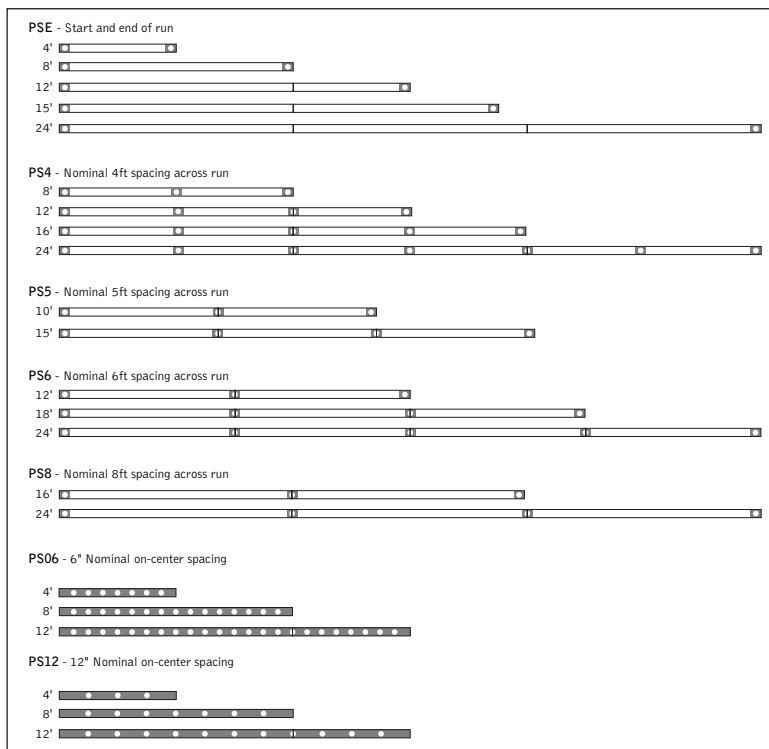

SPECIFICATIONS

LED System

Proprietary linear LED module incorporates premium LEDs on a robust platform to achieve excellent thermal management. LEDs are placed to promote a uniform appearance. Available in 2700K, 3000K, 3500K or 4000K with both 80 and 90 CRI options. LED modules and drivers are replaceable from below. Color accuracy <3 SDCM.

Construction

One piece extruded aluminum housing. 20 Ga. steel end caps. Housing for new construction applications. XFW acceptable for use with wood, consult factory for Type IC availability. 8' unit weight: 18.5lbs.

Optic

Reflectors fabricated of 22 Ga. steel finished in High Reflectance White powder coat. Extruded acrylic lens .07" thick with frosted finish, up to 8' continuous.

Electrical

Luminaires are pre-wired with factory installed branch circuit wiring and over-molded quick connects. Standard 120-277V constant current driver includes 0-10V analog dimming. Power factor > .9.

Emergency Battery

Emergency output - 10 watts for 90 minutes. See EM/EC Guide for default locations and ordering details.

Labels

UL and cUL listed. Suitable for Dry or Damp Locations, indoor use only.

Finish

Polyester powder coat applied over a multi-stage pre-treatment.

Lumen Maintenance

Linear Source

Reported: L70 at >61,000 hours Calculated: L70 at 470,000 hours
 L90 at >61,000 hours L90 at 115,000 hours

Point Source

Reported: L70 at >55,000 hours Calculated: L70 at 226,000 hours
 L90 at 54,000 hours L90 at 54,000 hours

Derived from EPA TM-21 calculator. Based on typical conditions, consult factory for additional data.

Reliability

At Focal Point, our products are designed to stand the test of time. Each luminaire is engineered using superior components, manufactured with the utmost care and rigorously tested. Contact us for reliability data.

Warranty

LED system rated for operation in ambient environments up to 25°C. 5-year limited warranty.

PERFORMANCE CHARTS

See page 3.

Focal Point LLC reserves the right to change specifications for product improvement without notification.





	ORDERING	FSM1D
	Luminaire Series	
	Seem 1 LED Point Source	FSM1D
	Shielding	
	Flush Lens	FL
	Batwing Lens	BW
	Point Source Only	PS
	Point Source Spacing	
FL & BW only	Start and End of Run	PSE
	Nominal 4ft Spacing	PS4
	Nominal 5ft Spacing	PS5
	Nominal 6ft Spacing	PS6
	Nominal 7ft Spacing	PS7
	Nominal 8ft Spacing	PS8
	Mixed Spacing <small>(See point source spacing guide for more options.)</small>	PSM
PS only	6" Nominal On-Center Spacing <small>(250L & 350L only)</small>	PS06
	12" Nominal On-Center Spacing <small>(Wider spacing available, consult factory.)</small>	PS12
	Point Source Lumens	
	250 Lumens <small>(PS shielding only)</small>	250L
	350 Lumens <small>(Consult factory for Lutron with FL or BW shielding.)</small>	350L
	450 Lumens	450L
	Point Source Distribution	
	Narrow Flood	NFL
	Flood 1	FL1
	Flood 2	FL2
	Wide Flood	WFL
	Linear Lumen Output	
PS only	No linear output, point source only	0LF
	125 Lumens per foot <small>(5' minimum length. See spacing guide for PS4 limitations. Consult factory for Lutron.)</small>	125LF
FL & BW only	250 Lumens per foot	250LF
	375 Lumens per foot	375LF
	500 Lumens per foot	500LF
	625 Lumens per foot	625LF
	Color Temperature	
	2700K, 80CRI or 90 CRI	27K or 927K
	3000K, 80CRI or 90 CRI	30K or 930K
	3500K, 80CRI or 90 CRI	35K or 935K
	4000K, 80CRI or 90 CRI	40K or 940K
	Circuit	
	Single Circuit	1C
	Dual Circuit <small>(FL & BW shielding only)</small>	2C
	Voltage	
	120/277 UNV Volt	UNV
	347 Volt <small>(LD1 driver only)</small>	347
	Control System & Dimming Level	
	0-10V - 10% Dimming	LD1
	0-10V - 1% Dimming	L11
	Lutron Hi-Lume EcoSystem (LDE1) - 1% Dimming	LH1
	Ceiling Configuration	
	Std. 15/16" Lay-in or Tegular	G1 or T1
	Std. 9/16" Lay-in or Tegular	G2 or T2
	9/16" Slot-tee Tegular	G3
	Tall 15/16" Lay-in or Tegular	G4 or T4
	Tall 9/16" Lay-in or Tegular	G5 or T5
	Node 9/16" Tegular	T6
	Mud-in Trimless	XFF
	Non-Drywall Hard Surface	XFN
	Hard Surface, Wood	XFW
	Factory Options	
	Chicago Plenum	CP
	Emergency Circuit <small>(Direct linear only on BW & FL shielding)</small>	_EC
	Emergency Battery Pack <small>(5' minimum length for BW & FL shielding, 4' minimum length for PS shielding. See EM/EC Guide for default locations and ordering details.)</small>	_EM
	6' New York City Flex Whip (120V)	FNY1
	6' New York City Flex Whip (277V)	FNY2
	6' Flex Whip	FW
	Finish	
	Black	BK
	Titanium Silver	TS
	Matte White Housing	WH
	Luminaire Length	
	Specify luminaire/row length in 1' increments <small>(4' minimum. Smaller increments available, consult factory.)</small>	_ft

PERFORMANCE CHART (4' LINEAR AREA)

Shielding	Lumens per Foot	Delivered Lumens	Tested System Watts	LPW
Flush Lens / Batwing Lens	125LF	500	6	75
	250LF	1000	10	98
	375LF	1500	15	104
	500LF	2000	19	106
	625LF	2500	24	103

Based on 3500K, 4' lengths. Lumen Multipliers: Preferred Light = 0.65, 90 CRI = 0.87 Lumen output may vary +/- 5%. Actual wattage may vary +/- 5%

PERFORMANCE CHART (POINT SOURCE)

Per Point Source				PS06		PS12		PSE			
Distribution	Beamspread	Point Source Lumens	Delivered Lumens	4' Luminaire				4-8' Luminaires		> 8' Luminaires	
				Tested System Watts	LPW	Tested System Watts	LPW	Tested System Watts	LPW	Tested System Watts	LPW
 Narrow Flood (NFL)	21°	250L	258	21	87	10	77	-	-	-	-
		350L	360	30	84	14	80	10	74	12	61
		450L	457	-	-	17	81	12	76	14	66
 Flood 1 (FL1)	28°	250L	254	21	86	10	76	-	-	-	-
		350L	354	30	83	14	78	10	73	12	60
		450L	450	-	-	17	79	12	75	14	66
 Flood 2 (FL2)	42°	250L	249	21	84	10	74	-	-	-	-
		350L	346	30	81	14	77	10	71	12	59
		450L	441	-	-	17	78	12	73	14	65
 Wide Flood (WFL)	53°	250L	242	21	82	10	72	-	-	-	-
		350L	337	30	79	14	75	10	69	12	57
		450L	429	-	-	17	75	12	71	14	63

Based on 3500K. Lumen output may vary +/- 5%. Actual wattage may vary +/- 5%

7 point sources

3 point sources

2 point sources

Seem® 1 Point Source

FLUSH AND BATWING LENS POINT SOURCE SPACING GUIDE

ON-CENTER SPACING EXAMPLES

PS4 - Nominal 4ft spacing across run

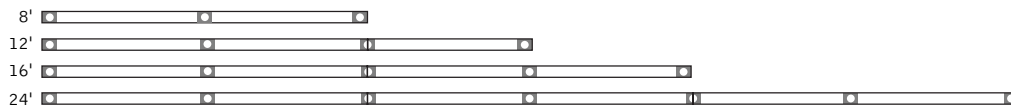

PS5 - Nominal 5ft spacing across run

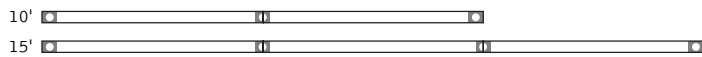

PS6 - Nominal 6ft spacing across run

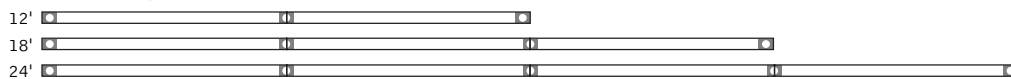

PS8 - Nominal 8ft spacing across run

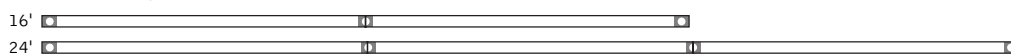

MIXED SPACING EXAMPLES

PSM - Mixed spacing across run. Point sources located at start and end of run as well as housing joints.

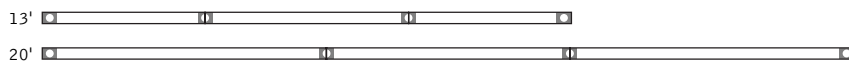

Luminaire Run Length (ft)	Run Configuration	Point Source Spacing Code	Total # Point Sources	Luminaire Run Length (ft)	Run Configuration	Point Source Spacing Code	Total # Point Sources
8	8'	PS4	3	30	5' + 5' + 5' + 5' + 5' + 5'	PS5	7
9	-	-	-	30	6' + 6' + 6' + 6' + 6'	PS6	6
10	5' + 5'	PS5	3	31	6' + 6' + 7' + 6' + 6'	PSM	6
11	-	-	-	32	8' + 8' + 8' + 8'	PS4	9
12	8' + 4'	PS4*	4	32	8' + 8' + 8' + 8'	PS8	5
12	6' + 6'	PS6	3	33	6' + 7' + 7' + 7' + 6'	PSM	6
13	4' + 5' + 4'	PSM*	4	34	7' + 7' + 6' + 7' + 7'	PSM	6
14	7' + 7'	PS7	3	35	5' + 5' + 5' + 5' + 5' + 5' + 5'	PS5	8
15	5' + 5' + 5'	PS5	4	35	7' + 7' + 7' + 7' + 7'	PS7	6
16	8' + 8'	PS4	5	36	8' + 8' + 8' + 8' + 4'	PS4*	10
16	8' + 8'	PS8	3	36	6' + 6' + 6' + 6' + 6' + 6'	PS6	7
17	6' + 5' + 6'	PSM	4	37	8' + 7' + 7' + 7' + 8'	PSM	6
18	6' + 6' + 6'	PS6	4	38	8' + 8' + 6' + 8' + 8'	PSM	6
19	6' + 7' + 6'	PSM	4	39	8' + 8' + 7' + 8' + 8'	PSM	6
20	8' + 8' + 4'	PS4*	6	40	8' + 8' + 8' + 8' + 8'	PS4	11
20	5' + 5' + 5' + 5'	PS5	5	40	8' + 8' + 8' + 8' + 8'	PS8	6
20	7' + 6' + 7'	PSM	4	40	5' + 5' + 5' + 5' + 5' + 5' + 5' + 5'	PS5	9
21	7' + 7' + 7'	PS7	4	41	6' + 6' + 6' + 5' + 6' + 6' + 6'	PSM	8
22	7' + 8' + 7'	PSM	4	42	6' + 6' + 6' + 6' + 6' + 6' + 6'	PS6	8
23	8' + 7' + 8'	PSM	4	42	7' + 7' + 7' + 7' + 7' + 7'	PS7	7
24	8' + 8' + 8'	PS4	7	43	6' + 6' + 6' + 7' + 6' + 6' + 6'	PSM	8
24	8' + 8' + 8'	PS8	4	44	8' + 8' + 8' + 8' + 8' + 4'	PS4*	12
24	6' + 6' + 6' + 6'	PS6	5	45	5' + 5' + 5' + 5' + 5' + 5' + 5' + 5' + 5'	PS5	10
25	5' + 5' + 5' + 5' + 5'	PS5	6	46	7' + 8' + 8' + 8' + 8' + 7'	PSM	7
26	7' + 6' + 6' + 7'	PSM	5	47	6' + 5' + 5' + 5' + 5' + 5' + 5' + 5' + 6'	PSM	10
27	6' + 5' + 5' + 5' + 6'	PSM	6	48	8' + 8' + 8' + 8' + 8' + 8'	PS4	13
28	8' + 8' + 8' + 4'	PS4*	8	48	8' + 8' + 8' + 8' + 8' + 8'	PS8	7
28	7' + 7' + 7' + 7'	PS7	5	48	6' + 6' + 6' + 6' + 6' + 6' + 6' + 6'	PS6	9
29	6' + 6' + 5' + 6' + 6'	PSM	6	>48	Consult Factory	-	-

*Not available with 125LF

Seem® 1 Point Source

POINT SOURCE ONLY SPACING GUIDE

ON-CENTER SPACING EXAMPLES

PS06 - 6" Nominal on-center spacing

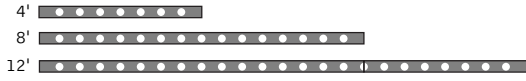

PS12 - 12" Nominal on-center spacing

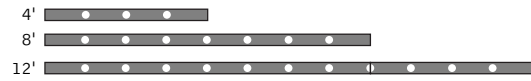

Luminaire Run Length (ft)	Run Configuration	Point Source Spacing Code	Total # Point Sources
4	4	PS06	7
5	5	PS06	9
6	6	PS06	11
7	7	PS06	13
8	8	PS06	15
9	5 + 4	PS06	17
10	6 + 4	PS06	19
11	7 + 4	PS06	21
12	8 + 4	PS06	23
13	8 + 5	PS06	25
14	8 + 6	PS06	27
15	8 + 7	PS06	29
16	8 + 8	PS06	31
17	8 + 5 + 4	PS06	32
18	8 + 6 + 4	PS06	34
19	8 + 7 + 4	PS06	36
20	8 + 8 + 4	PS06	38
21	8 + 8 + 5	PS06	40
22	8 + 8 + 6	PS06	42
23	8 + 8 + 7	PS06	44
24	8 + 8 + 8	PS06	46
25	8 + 8 + 5 + 4	PS06	47
26	8 + 8 + 6 + 4	PS06	49
27	8 + 8 + 7 + 4	PS06	51
28	8 + 8 + 8 + 4	PS06	53
29	8 + 8 + 8 + 5	PS06	55
30	8 + 8 + 8 + 6	PS06	57
31	8 + 8 + 8 + 7	PS06	59
32	8 + 8 + 8 + 8	PS06	61
33	8 + 8 + 8 + 5 + 4	PS06	62
34	8 + 8 + 8 + 6 + 4	PS06	64
35	8 + 8 + 8 + 7 + 4	PS06	66
36	8 + 8 + 8 + 8 + 4	PS06	68
37	8 + 8 + 8 + 8 + 5	PS06	70
38	8 + 8 + 8 + 8 + 6	PS06	72
39	8 + 8 + 8 + 8 + 7	PS06	74
40	8 + 8 + 8 + 8 + 8	PS06	76
41	8 + 8 + 8 + 8 + 5 + 4	PS06	77
42	8 + 8 + 8 + 8 + 6 + 4	PS06	79
43	8 + 8 + 8 + 8 + 7 + 4	PS06	81
44	8 + 8 + 8 + 8 + 8 + 4	PS06	83
45	8 + 8 + 8 + 8 + 8 + 5	PS06	85
46	8 + 8 + 8 + 8 + 8 + 6	PS06	87
47	8 + 8 + 8 + 8 + 8 + 7	PS06	89
48	8 + 8 + 8 + 8 + 8 + 8	PS06	91
>48	Consult Factory	-	-

Luminaire Run Length (ft)	Run Configuration	Point Source Spacing Code	Total # Point Sources
4	4	PS12	3
5	5	PS12	4
6	6	PS12	5
7	7	PS12	6
8	8	PS12	7
9	5 + 4	PS12	8
10	6 + 4	PS12	9
11	7 + 4	PS12	10
12	8 + 4	PS12	11
13	8 + 5	PS12	12
14	8 + 6	PS12	13
15	8 + 7	PS12	14
16	8 + 8	PS12	15
17	8 + 5 + 4	PS12	15
18	8 + 6 + 4	PS12	16
19	8 + 7 + 4	PS12	17
20	8 + 8 + 4	PS12	18
21	8 + 8 + 5	PS12	19
22	8 + 8 + 6	PS12	20
23	8 + 8 + 7	PS12	21
24	8 + 8 + 8	PS12	22
25	8 + 8 + 5 + 4	PS12	22
26	8 + 8 + 6 + 4	PS12	23
27	8 + 8 + 7 + 4	PS12	24
28	8 + 8 + 8 + 4	PS12	25
29	8 + 8 + 8 + 5	PS12	26
30	8 + 8 + 8 + 6	PS12	27
31	8 + 8 + 8 + 7	PS12	28
32	8 + 8 + 8 + 8	PS12	29
33	8 + 8 + 8 + 5 + 4	PS12	29
34	8 + 8 + 8 + 6 + 4	PS12	30
35	8 + 8 + 8 + 7 + 4	PS12	31
36	8 + 8 + 8 + 8 + 4	PS12	32
37	8 + 8 + 8 + 8 + 5	PS12	33
38	8 + 8 + 8 + 8 + 6	PS12	34
39	8 + 8 + 8 + 8 + 7	PS12	35
40	8 + 8 + 8 + 8 + 8	PS12	36
41	8 + 8 + 8 + 8 + 5 + 4	PS12	36
42	8 + 8 + 8 + 8 + 6 + 4	PS12	37
43	8 + 8 + 8 + 8 + 7 + 4	PS12	38
44	8 + 8 + 8 + 8 + 8 + 4	PS12	39
45	8 + 8 + 8 + 8 + 8 + 5	PS12	40
46	8 + 8 + 8 + 8 + 8 + 6	PS12	41
47	8 + 8 + 8 + 8 + 8 + 7	PS12	42
48	8 + 8 + 8 + 8 + 8 + 8	PS12	43
>48	Consult Factory	-	-