

ID+ 3.5" Cylinder

LED PENDANT WITH DECORATIVE REVEAL

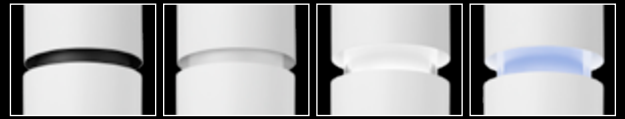

FOCAL POINT®



Black Non-Glow

White Non-Glow

White Glow

Custom RAL Glow

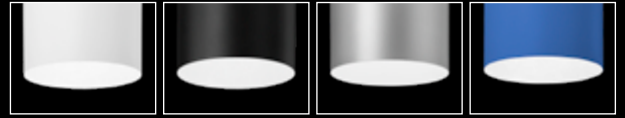

White

Black

Palladium Silver

Custom RAL

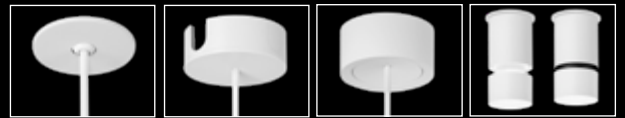

Shallow Canopy 50° Swivel Stem

Decorative Shallow Canopy

Power Canopy

Surface Mount Companions

DIMENSIONAL DATA (continued on page 3 & 4)

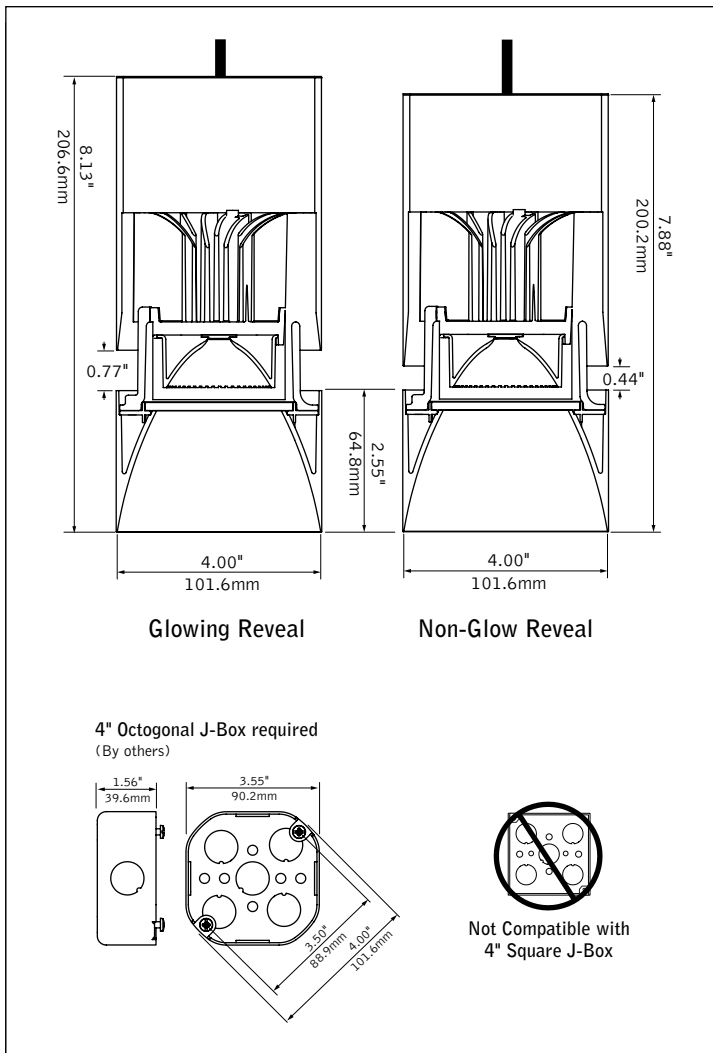

FEATURES

3.5" cylinder pendant with decorative reveal; glow or non-glow options.

Custom color options for finish and glowing reveal.

One-piece die-cast reflector with a knife edge for a modern aesthetic.

50° cut-off for brightness control and visual comfort.

Multiple canopy options enable various driver offerings and conduit installations while maintaining premier aesthetics.

Power cord, fixed and swivel stem suspension mounting options.

Warm Dim: Lighting that enhances spaces with a warm glow, reminiscent of incandescent or halogen light sources.

PoE compatible: Integrates with Power over Ethernet lighting systems via standard, low-voltage wires.

PERFORMANCE

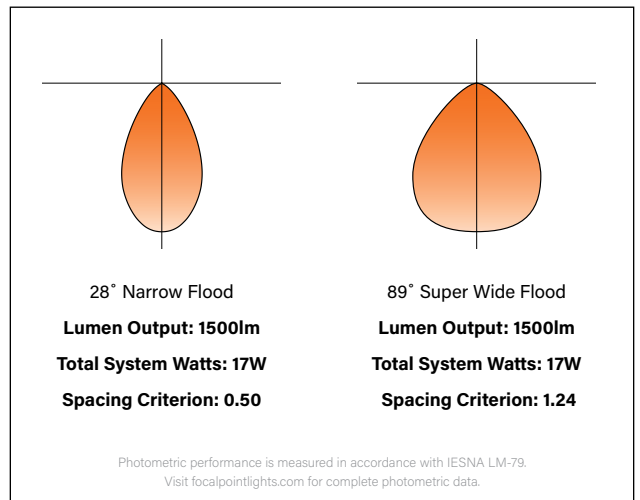

fixture:

project:

SPECIFICATIONS

LED System

Proprietary LED module with single light emitting source. May be specified in 2700K, 3000K, 3500K or 4000K in CRI>80 or CRI>90. 3500K and 4000K with CRI>90 have a cyanosis observation index (COI) of 3.3 or less. Color accuracy within 2 SDCM. Aluminum heat sink provides appropriate thermal management.

Construction

Upper housing is extruded aluminum. Lower reflector is die-cast aluminum. Twist & lock construction leaves no visible fasteners within the knife edge trim. Fixture will not exceed 5 lb.

Optics

Beam spreads achieved with optics that may be easily changed in field.

Cut-off degree	Distribution Beam Spread Spacing Criteria				
	NFL	FL1	FL2	WFL	SWFL
50°	28° 0.50	34° 0.59	45° 0.75	57° 0.80	—
80°	—	—	—	—	89° 1.24

Electrical

Choice of constant current dimming drivers. Power factor > .9 typical. PoE compatible: Integrates with Power over Ethernet lighting systems via standard, low-voltage wires. L11 & LFP with Shallow Canopy, Integral Driver not Right Light as standard, consult factory.

Emergency

Emergency output —7W for 90 minutes. Maximum mounting height: 16.98 ft. J-box cannot be recessed above the ceiling with Emergency Battery.

Labels

UL and cUL listed. Suitable for Dry or Damp Locations, indoor use only.

Finish

Polyester powder coat applied over a multi-stage pre-treatment. Swivel stem option is designed with a matching cylinder, swivel stem, and canopy finish.

Lumen Maintenance

Reported: L70 > 60,000 hours
L80 > 60,000 hours
Calculated: L70 at > 194,000 hours
L80 at > 120,000 hours
(Derived from EPA TM-21 calculator. Based on typical conditions, consult factory for additional data.)

Reliability

At Focal Point, our products are designed to stand the test of time. Each luminaire is engineered using superior components, manufactured with the utmost care and rigorously tested. Contact us for reliability data.

Warranty

LED system rated for operation in ambient environments up to 25°C. 5 year limited warranty.

PERFORMANCE TABLE

Lumen Output	Delivered Lumens	System Watts	LPW
700L	736	8	96
1000L	1082	12	94
1500L	1582	17	92
 1500L	1145	23	49
1700L	1743	19	91
2000L	2057	24	86

Glowing Reveal, 3500K, 80CRI, Clear Diffuse, Narrow Flood Distribution. Warm Dim based on 3000 - 1800K, 90 CRI. Lumen output may vary +/- 5%. Actual wattage may vary +/- 5%.

 **10 DAY** Options in orange qualify for the Quickship program. 10-day up to 50 pieces. Refer to Quickship Guide for complete details.

Focal Point LLC reserves the right to change specifications for product improvement without notification.

ORDERING

Luminaire Series	FLCY3	FLCY3
ID+ 3.5" Round Cylinder		
Trim Type	RD	RD
Round		
Decorative Reveal		
White Non-Glow Reveal	WHR	
Black Non-Glow Reveal	BKR	
White Glowing Reveal	WHG	
Custom Color Glowing Reveal	RAL_ _ _ _	
(Specify your RAL color value. Extended lead time consult factory.)		
Lumen Output		
700 Lumens	700L	
1000 Lumens	1000L	
1500 Lumens	1500L	
1700 Lumens	1700L	
2000 Lumens (PC & DPC only)	2000L	
Color Temperature		
2700K, 80+ CRI or 90+ CRI	27K or 927K	
3000K, 80+ CRI or 90+ CRI	30K or 930K	
3500K, 80+ CRI or 90+ CRI	35K or 935K	
4000K, 80+ CRI or 90+ CRI	40K or 940K	
Warm Dim: 2700-1800K, 90+ CRI	92718W	
Warm Dim: 3000-1800K, 90+ CRI	93018W	
(Warm Dim: 1500L only. EMR not available.)		
Circuit		1C
Single Circuit	1C	
Voltage		
120/277 UNV	UNV	
120 Volt	120	
277 Volt	277	
Low Voltage	LV	
Canopy Configuration		
Shallow Canopy, Integral Driver*	SC	
Shallow Canopy with decorative J-box cover, Integral Driver	DSC	
*(L11, LVN & LFP only)		
Power Canopy		PC
Power Canopy with decorative J-box cover	DPC	
Control System & Dimming Level		
0-10V - 0% Dimming	LZ1	
0-10V - 1% Dimming	L11	
Low Voltage, PoE compatible	LVN	
(No driver. Not available with EMR, SC or DSC with LV Voltage only.)		
Phase Dimming		LFP
(SC with 120V only. Consult factory for recommended dimmers.)		
Lutron Hi-Lume EcoSystem (LDE1) - 1% Dimming	LH1	
Lutron Hi-Lume - Forward Phase - 1% Dimming (120V only, 1000L max.)	LTE	
DALI - 0% Dimming	DZ1	
DALI - 1% Dimming	D11	
Mounting		
72" Cable, Straight Feed (Cut in field)	C72	
144" Cable, Straight Feed (Cut in field)	C144	
12", 50° Swivel Stem	B12	
18", 50° Swivel Stem	B18	
2'- 8' in 1' increments, 50° Swivel Stem	B_	
(Specify in inches, example: 8' stem = B96)		
12", Fixed Stem	S12	
18", Fixed Stem	S18	
2'- 8' in 1' increments, Fixed Stem	S_	
(Specify in inches, example: 8' stem = S96)		
Optic		
50° Cut-off Cone	DNT	
(Not available with SWFL distribution)		
50° Cut-off Cone with Solite Lens	DNTS	
(NFL distribution only)		
80° Cut-off Cone	DSS	
(SWFL distribution only)		
Distribution		
Narrow Flood	NFL	
Flood 1	FL1	
Flood 2	FL2	
Wide Flood	WFL	
Super Wide Flood	SWFL	
Factory Options		
Emergency Battery	EMR	
(J-box cannot be recessed above the ceiling. Remote test switch.)		
Reflector Color		CD
Clear Diffuse	CD	
Luminaire Finish		
(Cylinder, swivel stem and canopy finish match)		
Black with Black cord	BK	
White with White cord	BH	
Palladium Silver with Black cord	PS	
Custom Color with White cord	RAL_ _ _ _	
(Specify your RAL color value. Extended lead time consult factory.)		

DIMENSIONAL DATA CONTINUED

SC - Shallow Canopy, Integral Driver

■ Indicates Driver Location

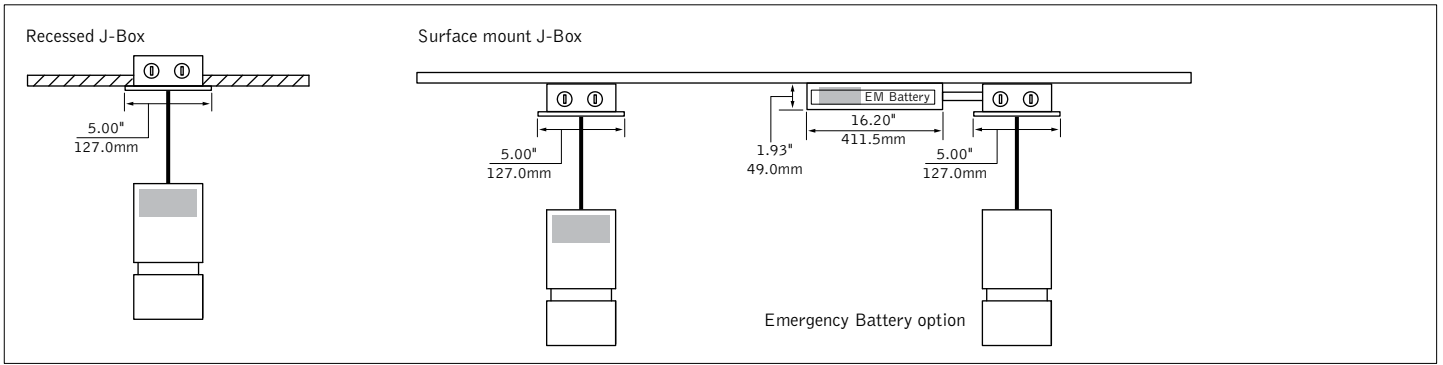

PC - Power Canopy

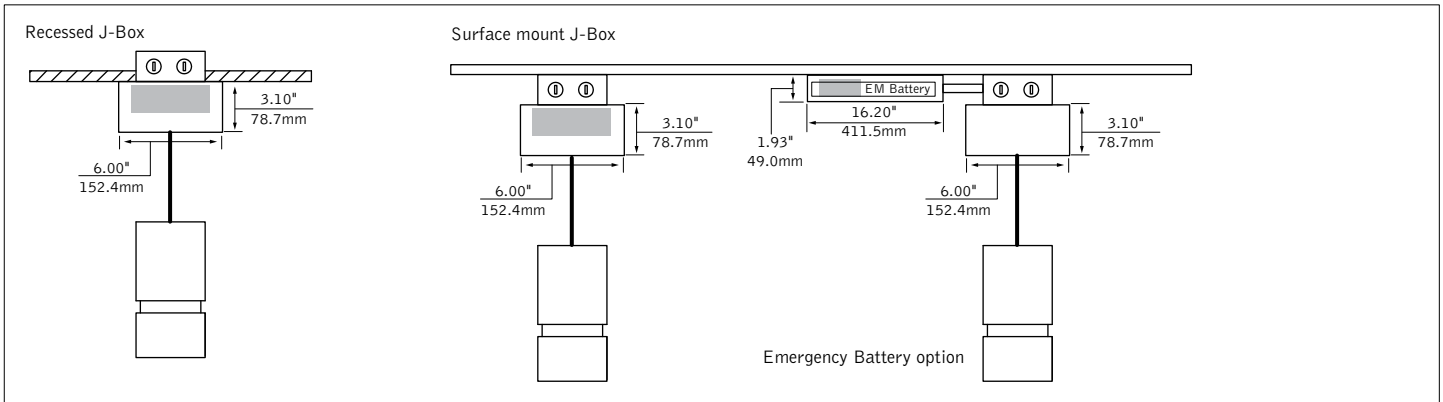

DSC - Shallow Canopy with decorative J-box cover, Integral Driver

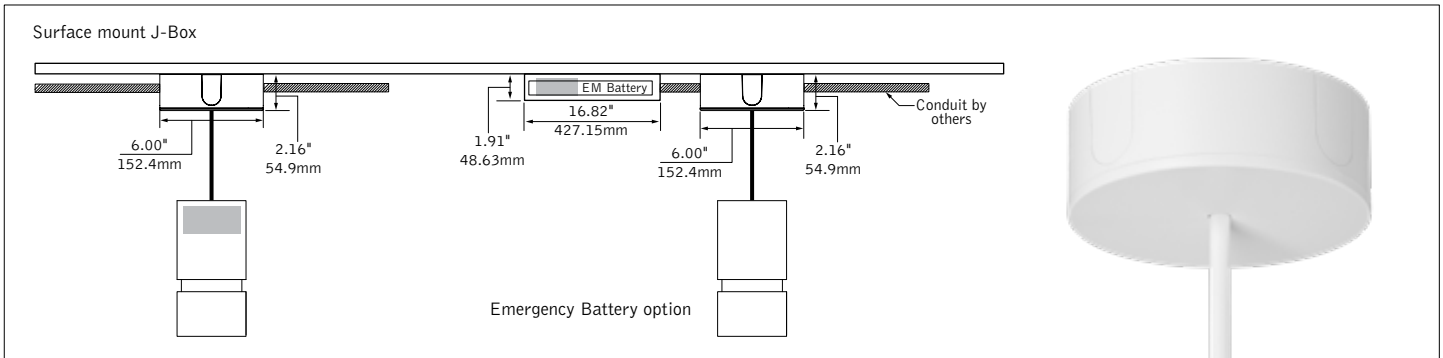

DPC - Power Canopy with decorative J-box cover

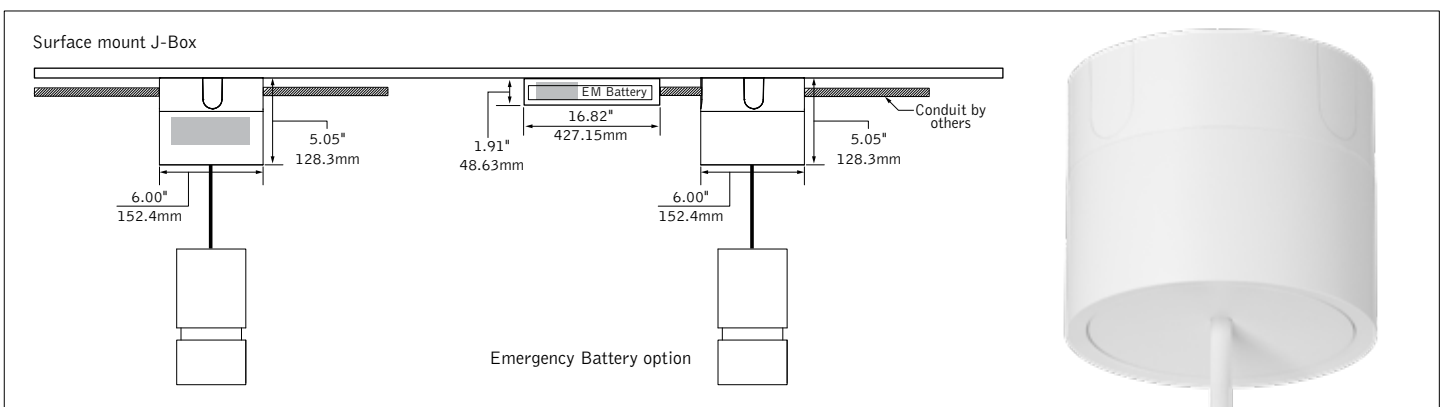

3.5" CYLINDER LUMEN MULTIPLIER TABLE

Color Temperature & CRI

Trim Type	Optic	Color Temperature	Multiplier
Round [RD]	ALL	2700K, 80+ CRI [27K]	0.93
		2700K, 90+ CRI [927K]	0.78
		3000K, 80+ CRI [30K]	0.97
		3000K, 90+ CRI [930K]	0.81
		3500K, 80+ CRI [35K]	1.00
		3500K, 90+ CRI [935K]	0.83
		4000K, 80+ CRI [40K]	1.01
		4000K, 90+ CRI [940K]	0.86
		2700-1800K, 90+ CRI [92718W]	0.76
3000-1800K, 90+ CRI [93018W]	0.72		

Optic & Distribution

Trim Type	Optic	Distribution	Multiplier
Round [RD]	Tall Cone, 50° cut-off [DNT]	Narrow Flood (28°) [NFL]	1.00
		Flood 1 (34°) [FL1]	0.89
		Flood 2 (45°) [FL2]	0.75
		Wide Flood (57°) [WFL]	0.75
	Tall Cone, 50° cut-off with Solite Lens [DNLS]	Narrow Flood (28°) [NFL]	0.97
	Super Short Cone, 80° cut-off [DSS]	Super Wide Flood (89°) [SWFL]	0.74

Multiplier tables are provided to aid with estimation of lumen levels across options. Apply multipliers against ordered Lumen Output to estimate Delivered Lumens. Refer to IES files for most accurate photometric information.

How To Use Lumen Multipliers

Formula: (Lumen Output Value) x (Color Temperature & CRI) x (Optic & Distribution)

Example: FLCY3-RD-1000L-935K-DNT-FL1

(1000) x (0.83) x (0.87) ≈ 722 lm (estimated delivered lumens)

NON-SCALLOPING SUPER WIDE FLOOD DESIGN GUIDE - 1500 LUMEN EXAMPLE

Distance from bottom of fixture	Footcandles					
	Fixtures 3' from Wall		Fixtures 3.5' from Wall		Fixtures 4' from Wall	
	3' OC	3.5' OC	3' OC	3.5' OC	3' OC	3.5' OC
10'	3"	2 2 2	2 2 2	2 2 2	2 2 2	1 1 1
	6"	2 2 2	2 2 2	2 2 2	2 2 2	2 2 2
	9"	3 3 3	3 3 3	3 3 3	2 2 2	2 2 2
	12"	3 3 3	3 3 3	3 3 3	2 2 2	2 2 2
2'	8 8 8	7 7 7	6 6 6	5 5 5	5 5 5	4 4 4
3'	15 15 15	13 13 13	11 11 11	10 10 10	8 8 8	7 7 7
4'	19 19 19	16 16 16	15 15 15	13 13 13	12 12 12	11 11 11
5'	19 19 19	16 16 16	17 17 17	15 15 15	15 15 15	13 13 13
6'	17 17 17	14 14 14	16 16 16	14 14 14	15 15 15	13 13 13
7'	15 15 15	13 13 13	15 15 15	13 13 13	14 14 14	12 12 12
8'	13 13 13	11 11 11	13 13 13	11 11 11	13 13 13	11 11 11
9'	11 11 11	9 9 9	11 11 11	10 10 10	12 12 12	10 10 10
10'	9 9 9	8 8 8	10 10 10	8 8 8	10 10 10	9 9 9

