

# Equation™ 2 1x4

LED

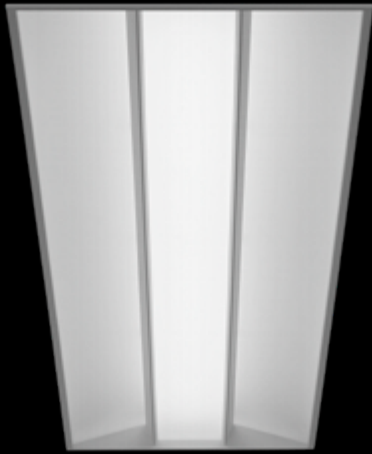

opal acrylic lens



MicroGlow lens



suspended or surface mount

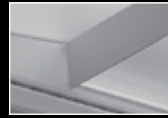

air return

## DIMENSIONAL DATA

2000 - 5000 Lumens

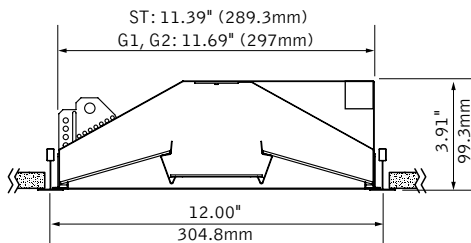

5500 - 6500 Lumens  
thermal protector required

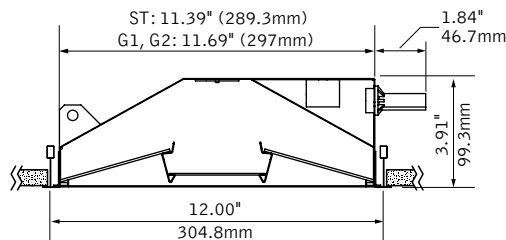

Overall height of luminaire:  
with air return is 4.62"– 4.89"  
with L1TW option 4.52"

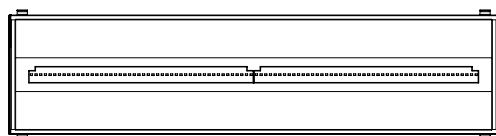

2 LED boards

## FEATURES

Equation™ 2 blends sleek aesthetics with uniform diffuse illumination.

Center diffuser features MicroGlow prismatic lens for brightness control and visual comfort. Opal acrylic center lens may also be specified.

Tunable White: Supports human activity, well-being, and preferences with a light quality that evolves throughout the day.

Connected Solutions: Integrates with wired and wireless building lighting control systems.

PoE compatible: Integrates with Power over Ethernet lighting systems via standard, low-voltage wires.

## PERFORMANCE

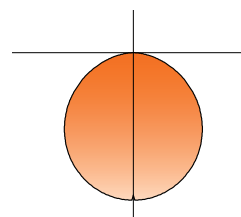

Opal Acrylic Lens  
**Delivered Lumens: 3500lm**  
**Total System Watts: 37W**

### PRODUCT OVERVIEW

Lumen Output:	2000-6500lm
Wattage:	19-68W
LPW:	89-109
SDCM:	3

Photometric performance is measured in accordance with IESNA LM-79. Visit [focalpointlights.com](http://focalpointlights.com) for complete photometric data.

**MOUNTING INFORMATION**

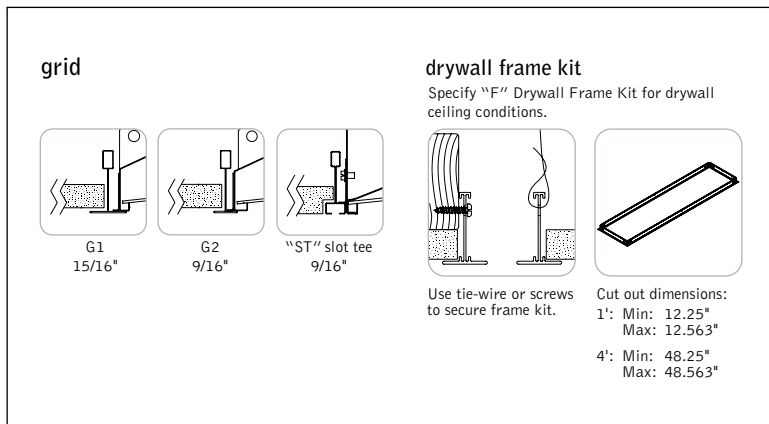

**SPECIFICATIONS**

**LED System**

Proprietary linear LED module incorporates premium LEDs on a robust platform to achieve excellent thermal management. LEDs are placed to promote a uniform appearance. Available in 2700K, 3000K, 3500K, 4000K or Tunable White (2700K-6500K), with CRI>80 or CRI>90, 3SDCM. 3500K and 4000K with CRI>90 have a cyanosis observation index (COI) of 3.3 or less. Contact factory for additional color temperature and CRI options. 0-10V dimming driver standard. LED modules and drivers are replaceable from below.

**Construction**

One-piece 24 Ga. steel reflector and housing. Bottom access 24 Ga. steel driver compartment. Positional brackets supplied as standard. Standard weight: 19.4 lbs. Surface-mount/suspended weight: 24.2 lbs.

**Optic**

24 Ga. steel reflectors finished in matte satin white powder coat. .080" thick frosted white acrylic diffusers. Center shielding options include .080" thick opal acrylic lens or MicroGlow prismatic lens with optical filter overlay.

**Electrical**

Standard 120-277V driver includes 0-10V analog dimming. Power factor > .9. Optional DALI, Lutron EcoSystem or Step-dimming drivers available. PoE compatible: Integrates with Power over Ethernet lighting systems via standard, low-voltage wires.

**Emergency**

Emergency battery output—10 watts for 90 minutes. Emergency Circuit with Connected Solutions (DLM1, LMFS1, LMFS1D, NLT1, ENL1, CLM1, NXE1, WLXP) requires a UL924 compliant device, consult factory.

**Labels**

UL and cUL listed. Suitable for Dry or Damp Locations, indoor use only.

**Finish**

Polyester powder coat applied over a multi-stage pre-treatment.

**Lumen Maintenance**

Reported: L70 at >61,000 hours      Calculated: L70 at 480,000 hours  
L80 at >61,000 hours                  L80 at 285,000 hours  
(Derived from EPA TM-21 calculator. Based on typical conditions, consult factory for additional data.)

**Reliability**

At Focal Point, our products are designed to stand the test of time. Each luminaire is engineered using superior components, manufactured with the utmost care and rigorously tested. Contact us for reliability data.

**Warranty**

LED system rated for operation in ambient environments up to 25°C. 5-year limited warranty.

**STANDARD WHITE PERFORMANCE CHART**

Lumen Output	Tested System Watts	LPW	Lumen Output	Tested System Watts	LPW
2000	17	113	4500	41	107
2500	22	111	5000	46	107
3000	27	110	5500	60	92
3500	32	109	6000	67	89
4000	36	108	6500	76	86

Based on 3500K, 80 CRI, Opal Acrylic Lens. Lumen multipliers: 90+ CRI = 0.87, MicroGlow Prismatic Lens = 0.95. Lumen output may vary +/- 5%. Actual wattage may vary +/- 5%.

**STANDARD WHITE**

**Luminaire Series**

Equation 2 FEQ2

**Nominal Size**

1' x 4' 14

**Shielding**

Opal Acrylic Lens AC  
MicroGlow Prismatic Lens MG

**Lumen Output**

2000 Lumens 2000L  
2500 Lumens 2500L  
3000 Lumens 3000L  
3500 Lumens 3500L  
4000 Lumens 4000L  
4500 Lumens 4500L  
5000 Lumens 5000L  
5500 Lumens\* 5500L  
6000 Lumens\* 6000L  
6500 Lumens\* 6500L

(\*Grid, Slot Tee Only)

**Color Temperature**

2700K, 80+ CRI or 90+ CRI 27K or 927K  
3000K, 80+ CRI or 90+ CRI 30K or 930K  
3500K, 80+ CRI or 90+ CRI 35K or 935K  
4000K, 80+ CRI or 90+ CRI 40K or 940K

**Circuit**

Single Circuit 1C

**Voltage**

UNV 120/277 Volt UNV

(5000 Lumens max.)

120 Volt 120

277 Volt 277

347 Volt 347

(Transformer required for all drivers except LDI and CLM1. Not available with EM.)

Low Voltage LV

**Control System & Dimming Level**

0-10V - 10% Dimming LD1

(Not Right Light as standard, consult factory)

0-10V - 1% Dimming L11

Low Voltage, PoE compatible LVN

(No driver. Not available with EM. LV Voltage only)

Lutron Hi-Lume EcoSystem (LDE1) - LH1

1% Dimming

DALI - 1% Dimming D11

Step Dimming SD5

Wattstopper DLM - 1% Dimming DLM1

(Not available with CP)

Wattstopper Fixture Sensor LMFS1

Low Density - 1% Dimming LMFS1D

Wattstopper Fixture Sensor High Density - 1% Dimming NLT1

Acuity nLight - 1% Dimming (Not available with CP)

Enlighted Smart Sensor - 1% Dimming ENL1

Encelium CLM Connected Lighting Module - 1% Dimming CLM1

Current NX Enabled - 1% Dimming NXE1

(Not available with CP)

WaveLinX Pro - 1% Dimming WLXP

**Mounting**

24" Aircraft Cable C24

48" Aircraft Cable C48

96" Aircraft Cable C96

Drywall Frame Kit F

(Not available with CLM1, DLM1, NLT1 or NXE1)

(Cut out dimensions: Min: 12.25"/Max: 12.563"

Min: 48.25"/Max: 48.563")

15/16" Grid G1

9/16" Grid G2

Slot Tee ST

Surface Mount SM

(Not available with CLM1, DLM1, NLT1 or NXE1)

**Factory Options**

**Air Return**

AR

(Overall height with Air Return is 4.62"-4.89")

**Chicago Plenum**

CP

(Not available with flex whip)

**Emergency Battery with Integral Test Switch**

EM

(Cannot combine with 347V)

6' New York City Flex Whip (120V) FNY1

6' New York City Flex Whip (277V) FNY2

6' Flex Whip FW

**Finish**

Matte Satin White WH



**5/10 DAY**

Options in orange qualify for the Quickship program. 5-day up to 50 pieces, 10-day up to 150 pieces. Refer to Quickship Guide for complete details.

fixture:

project:

**MOUNTING INFORMATION**

**grid**

G1  
15/16"

G2  
9/16"

"ST" slot tee  
9/16"

**drywall frame kit**

Specify "F" Drywall Frame Kit for drywall ceiling conditions.

Use tie-wire or screws to secure frame kit.

Cut out dimensions:  
1': Min: 12.25"  
Max: 12.563"  
4': Min: 48.25"  
Max: 48.563"

**TUNABLE WHITE PERFORMANCE CHART**

Lumen Output	Delivered Lumens	Tested System Watts	LPW
2000L	2001	24	82
2500L	2508	30	83
3000L	3009	35	87
3500L	3503	40	87
4000L	4010	46	87
4500L	4508	52	88
5000L	4999	62	81
5500L	5500	69	80
6000L	6011	75	80
6500L	6478	82	79

Based on 2700K, 80 CRI, Opal Acrylic Lens. Lumen output may vary +/- 5%. Actual wattage may vary +/- 5%.

**Lumen Multipliers**

CRI	Multiplier
80+	1.00
90+	0.89

Shielding	Multiplier
AC	1.00
MG	0.94

**Wattage Multipliers**

CCT	Multiplier
2700K	1.00
3000K	0.92
3500K	0.88
4000K	0.86
5000K	0.85
5700K	0.87
6500K	0.90



**TUNABLE WHITE  
Luminaire Series**

Equation 2	FEQ2
<b>Nominal Size</b>	<b>1' x 4'</b>
<b>Shielding</b>	<b>AC</b>
Opal Acrylic Lens	MG
MicroGlow Prismatic Lens	
<b>Lumen Output</b>	
2000 Lumens	2000L
2500 Lumens	2500L
3000 Lumens	3000L
3500 Lumens	3500L
4000 Lumens	4000L
4500 Lumens	4500L
5000 Lumens	5000L
5500 Lumens*	5500L
6000 Lumens*	6000L
6500 Lumens*	6500L

(\*Grid, Slot Tee Only)

**Color Temperature**

Tunable White: 2700-6500K, 80+ CRI	2765T
Tunable White: 2700-6500K, 90+ CRI	92765T

**Circuit**

Single Circuit	1C
----------------	----

**Voltage**

UNV 120/277 Volt (5000 Lumens max.)	UNV
120 Volt	120
277 Volt	277

**Control System & Dimming Level**

0-10V - 1% Dimming (Not available with surface or cable mount. Overall luminaire height increases to 4.52")	L1TW
Lutron T-Series - 1% Dimming	LT1
DALI - 1% Dimming (DT6 control. Requires two addresses, one for intensity & one for CCT tuning. Consult factory for DT8.)	D1TW

**Mounting**

24" Aircraft Cable (Not available with L1TW)	C24
48" Aircraft Cable (Not available with L1TW)	C48
96" Aircraft Cable (Not available with L1TW)	C96

**Drywall Frame Kit**

(Cut out dimensions: Min: 12.25"/Max: 12.563"  
Min: 48.25"/Max: 48.563")

15/16" Grid G1

9/16" Grid G2

Slot Tee ST

Surface Mount (Not available with L1TW) SM

**Factory Options**

Air Return (Overall height with Air Return is 4.62"-4.89")	AR
Chicago Plenum (Not available with flex whip)	CP
Emergency Battery with Integral Test Switch	EM
6' New York City Flex Whip (120V)	FNY1
6' New York City Flex Whip (277V)	FNY2
6' Flex Whip	FW
<b>Finish</b>	<b>WH</b>
Matte Satin White	WH

Focal Point provides flexibility in meeting the needs of each project by integrating with several building lighting control systems. A variety of sensors, drivers and other components can be specified that allow the luminaires to communicate with wired and wireless networks. All zoning can be digitally reconfigured through the application software. Daylight harvesting, occupancy sensing, integration with HVAC systems, and individual controls enable the monitoring and modulating of light levels and temperature in order to save energy, reduce costs and maximize occupants' comfort. All Connected Solutions luminaires require a compatible building control system.†

Connected Solution	Ordering Code	Model #**	Protocol	Compatible Networks*	Occupancy & Daylight	Temperature Reporting	Communication to Luminaire	Drivers	
 <b>legrand</b> WATTSTOPPER®		DLM1	LMFC-011	DLM	DLM	Enabled	No	Wired 	<b>Advance by Signify,</b> Optotronic by eldoLED
		LMFS1	LMFS-601 & LMFI-111	DLM Wireless	DLM	Enabled	No	Wireless	<b>Advance by Signify</b>
		LMFSD	LMFS-601						Optotronic by eldoLED (Dexal)
 <b>COOPER</b> Lighting Solutions		WLXP	OEM-WAA	WaveLinx Wireless	WaveLinx Pro Trellix	Enabled	No	Wireless (WaveLinx Pro Wireless Area Controller)	<b>Advance by Signify</b>
 <b>CRESTRON</b>		D11	Specified Driver	DALI	Crestron Züm Wireless & SpaceBuilder	Enabled	No	Wired	<b>eldoLED ECOdrive</b>
		L11		0-10V					<b>Advance by Signify</b>
 <b>ENCELIUM</b>		CLM1	ZBHA-CLM-DIM-ENC	ZigBee	Encelium X Light Management System	Enabled	No	Wireless	<b>Optotronic by eldoLED</b> Advance by Signify
 <b>Enlighted</b>		ENL1	SU-5E-IOT	Enlighted RF	Enlighted	Integrated	Yes	Wireless	<b>Advance by Signify</b>
 <b>LUTRON</b>		LH1	LDE1	EcoSystem	Quantum, Energi Savr Node, Energi TriPak	Enabled	No	Wired	<b>Lutron Hi-Lume</b>
 <b>nLIGHT</b>		NLT1	nEPS-60-IO	nLight	nLight	Enabled	No	Wired 	<b>eldoLED ECOdrive,</b> eldoLED SOLOdrive
								Wireless 	
 <b>LIGHTING CONTROLS</b>		NXE1	NXFM-LV	NX	NX Distributed Intelligence	Enabled	No	Wired 	<b>Optotronic by eldoLED</b>

\*Not all compatible networks may be listed. \*\*For performance data and additional control system details please visit the connected solutions manufacturer websites. Primary drivers are listed in bold. To specify a particular driver please consult factory. †Controls systems supplied by others.