

Avenue® 6

LED



corrugated regressed trim



solid regressed trim



flush lens

DIMENSIONAL DATA

grid mount (regress trim shown)

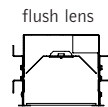
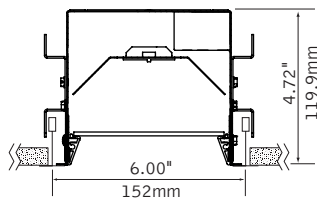

drywall flange

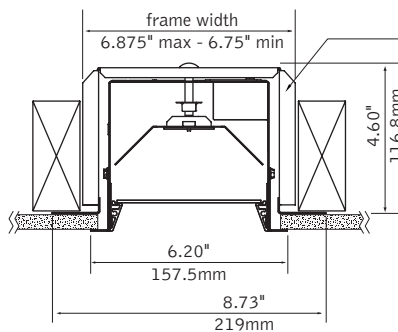

Mounting yoke must be installed prior to drywall.

FEATURES

Avenue® 6 LED is designed to function with specialty 6" ceiling systems, standard grid or drywall.

Shielding options include corrugated or solid regressed trim or flush lens.

Avenue® 6 LED provides an integrated lighting solution that complements the ceiling and entire space while providing comfortable general illumination.

Connected Solutions: Integrates with wired and wireless building lighting control systems.

PERFORMANCE

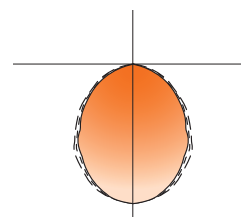

PRODUCT OVERVIEW

Lumen Output:	1500-4000lm
Wattage:	19-56W
LPW:	71-79
SDCM:	3

625 Lumens per foot
4' Housing with Flush Lens

Delivered Lumens: 2500lm

Total System Watts: 34W

Photometric performance is measured in accordance with IESNA LM-79.
Visit focalpointlights.com for complete photometric data.

fixture:

project:

MOUNTING INFORMATION

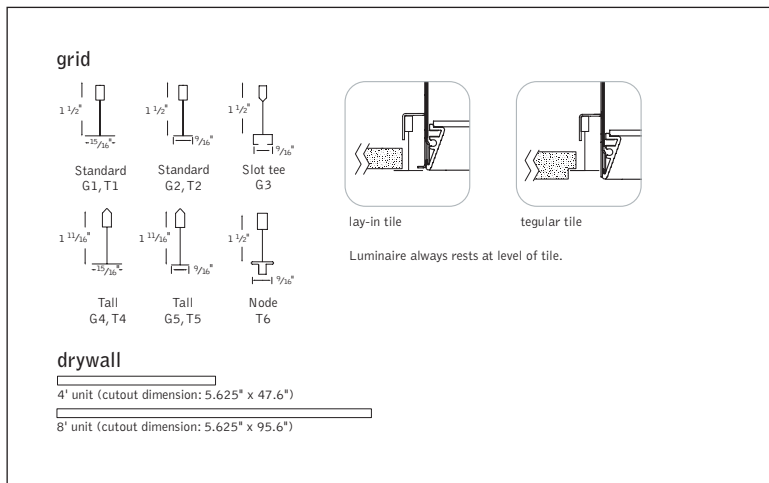

SPECIFICATIONS

LED System

Proprietary linear LED module incorporates premium LEDs on a robust platform to achieve excellent thermal management. LEDs are placed to promote a uniform appearance. Available in 2700K, 3000K, 3500K or 4000K with CRI>80 or CRI>90, 3 SDCM. LED modules and drivers are replaceable from below.

Construction

One-piece 20 Ga. steel housing. Thermally protected housing for new construction applications without direct contact with insulation. Insulation to be kept 3" away from housing. Corrugated and solid regressed trim constructed of 6063-T5 extruded aluminum finished in Matte Satin White. 20 Ga. steel, universal flange rail finished in Matte Satin White. Positional brackets supplied as standard. 4' unit weight: 15 lbs.

Optic

22 Ga. steel reflectors finished in High Reflectance White powder coat. Acrylic lens diffuser .118" thick, frosted clear.

Electrical

Thru-wiring not available.

Emergency

Emergency battery output - 10 watts for 90 minutes. Maximum mounting height: 20ft. Emergency Circuit with Connected Solutions (NLT1, ENL1, CLM1, DLM1) shipped standard with leads to connect UL924 compliant device, by others.

Labels

UL and cUL Listed. Suitable for Dry or Damp Locations, indoor use only.

Finish

Polyester powder coat applied over a multi-stage pre-treatment.

Lumen Maintenance

Reported: L70 > 60,000 hours Calculated: L70 at > 68,000 hours
 L90 > 21,000 hours L90 at > 21,000 hours
 (Derived from EPA TM-21 calculator. Based on typical conditions, consult factory for additional data.)

Reliability

At Focal Point, our products are designed to stand the test of time. Each luminaire is engineered using superior components, manufactured with the utmost care and rigorously tested. Contact us for reliability data.

Warranty

LED system rated for operation in ambient environments up to 25°C. 5-year limited warranty.

4' PERFORMANCE CHART

Shielding	Lumen Output	Delivered Lumens	System Watts	LPW
Flush Lens	375LF	1500	19	79
	625LF	2500	34	74
	875LF	3500	49	71
	1000LF	4000	56	71

Based on 3500K, 80 CRI, 4' lengths. Lumen Multipliers: Solid Regressed Trim (SR) = 1.3, 90+ CRI = 0.87. Lumen output may vary +/- 5%. Actual wattage may vary +/- 5%.

Focal Point LLC reserves the right to change specifications for product improvement without notification.

ORDERING

Luminaire Series	FAV6L
Avenue 6 LED	FAV6L
Shielding	
Corrugated Regressed Trim Frst.Lns	CR
Solid Regressed Trim Frosted Lens	SR
Flush Frosted Lens	FL
LED Output	
375 Lumens per foot	375LF
625 Lumens per foot	625LF
875 Lumens per foot	875LF
1000 Lumens per foot	1000LF
Color Temperature	
2700K, 80+ CRI or 90+ CRI	27K or 927K
3000K, 80+ CRI or 90+ CRI	30K or 930K
3500K, 80+ CRI or 90+ CRI	35K or 935K
4000K, 80+ CRI or 90+ CRI	40K or 940K
Circuits	
Single Circuit	1C
Voltage	
120/277 UNV Volt	UNV
Control System & Dimming Level	
0-10V - 1% Dimming	L11
0-10V - 10% Dimming	LD1
Lutron Hi-Lume EcoSystem (LDE1) - 1% Dimming	LH1
Step Dimming	SD5
Acuity nLight - 1% Dimming <small>(Not available with Chicago Plenum)</small>	NLT1
Enlighted Smart Sensor - 1% Dimming	ENL1
Osram Connected Lighting Module - 1% Dimming <small>(Compatible with Daintree Networks & Osram ENCELUM and ENCELUM EDGE systems)</small>	CLM1
Wattstopper DLM - 1% Dimming	DLM1
Ceiling Configurations	
Drywall Flange <small>(Not available with CLM1, DLM1 or ENL1)</small>	F
Std. 15/16" Lay-in	G1
Std. 15/16" Tegular	T1
Std. 9/16" Lay-in	G2
Std. 9/16" Tegular	T2
9/16" Slot-tee Tegular	G3
Tall 15/16" Lay-in	G4
Tall 15/16" Tegular	T4
Tall 9/16" Lay-in	G5
Tall 9/16" Tegular	T5
Node 9/16" Tegular	T6
Factory Options	
Chicago Plenum	CP
Emergency Battery <small>(DLM1 and ENL1 8' length only)</small>	EM
6' New York City Flex Whip (120V)	FNY1
6' New York City Flex Whip (277V)	FNY2
6' Flex Whip	FW
Finish	
Matte White Housing	WH
Luminaire Length	
4' Nominal Housing	4'
8' Nominal Housing	8'



Options in orange qualify for the Quickship program. 10-day up to 100 pieces. Refer to Quickship Guide for complete details.

Focal Point provides flexibility in meeting the needs of each project by integrating with several building lighting control systems. A variety of sensors, drivers and other components can be specified that allow the luminaires to communicate with wired and wireless networks. All zoning can be digitally reconfigured through the application software. Daylight harvesting, occupancy sensing, integration with HVAC systems, and individual controls enable the monitoring and modulating of light levels and temperature in order to save energy, reduce costs and maximize occupants' comfort. All Connected Solutions luminaires require a compatible building control system.†

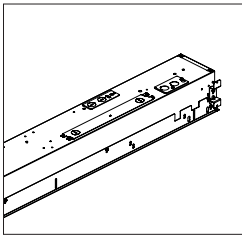

nLight® provides a two-way wired digital lighting system allowing for on/off and dimming functionality, occupancy sensing, and multi-zone daylight harvesting.

Acuity nLight - 1% Dimming (NLT1)
Acuity Model #nEPS-60-IO

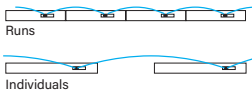

CAT-5 Cable provided by others. Serial labels will be provided on outside of luminaires and control unit.

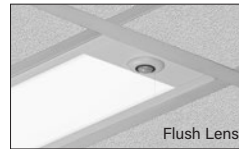

Flush Lens

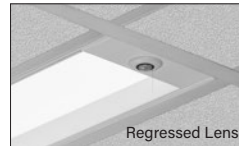

Regressed Lens



Enlighted smart sensor allows for occupancy sensing, daylight harvesting, energy usage, temperature and light level control. Communicates wirelessly with the Enlighted network.

Enlighted Smart Sensor - 1% Dimming (ENL1)
Enlighted Model #SU-5E-IOT

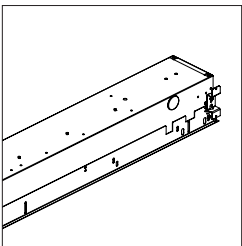

Connected Lighting Module (CLM) enables each luminaire to be independently controlled and configured. Communicates wirelessly with Daintree Networks®, Osram ENCELIUM®, Osram ENCELIUM EDGE™, and other networks using the ZigBee® HA communication protocol to allow for on/off and dimming functionality, occupancy sensing and multi-zone daylight harvesting.

Osram CLM - 1% Dimming (CLM1)
Osram Model #ZBHA-CLM DIM

Serial labels will be provided on outside of luminaires and control unit.

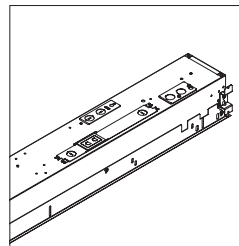

A Digital Lighting Management (DLM) system that provides two-way wired communication between networked luminaires and control system to allow for on/off and dimming functionality, occupancy sensing and multi-zone daylight harvesting.

Wattstopper DLM - 1% Dimming (DLM1)
Wattstopper Model #LMFC-011

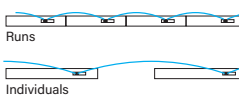

CAT-5 Cable provided by others. Serial labels will be provided on outside of luminaires and control unit.

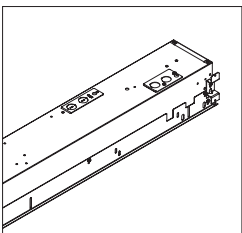

A two-way digital network that enables on/off and dimming functionality, occupancy sensing, and multi-zone daylight harvesting working with Quantum®, Energi Savr Node™, and Energi TriPak® using EcoSystem® communication protocol.

Lutron Hi-Lume EcoSystem - 1% Dimming (LH1)
Lutron Model #LDE1

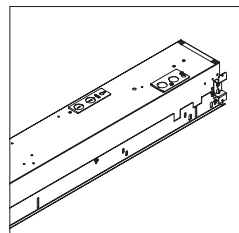

A two-way digital network that enables on/off and dimming functionality, occupancy sensing, and multi-zone daylight harvesting. Communicates with Züm wireless and SpaceBuilder working with Züm hub scheduling or FUSION management.

0-10V - 1% Dimming (L11)
Note: 0-10V is not a digital network but is compatible with Creston Züm™ system.

CONNECTED SOLUTIONS DETAILS

Connected Solution	Model #	Protocol	Compatible Networks*	Occupancy	Daylight	Temperature Reporting	Communication to Luminaire	Drivers
Acuity nLight (NLT1)	nEPS-60-IO**	nLight	nLight	Enabled	Enabled	No	Wired	eldoLED ECOdrive , eldoLED SOLOdrive
Crestron (L11)	Specified Driver	0-10V	Crestron Züm Wireless & SpaceBuilder	Enabled	Enabled	No	Wired	Advance by Signify
Enlighted Smart Sensor (ENL1)	SU-5E-IOT**	Enlighted RF	Enlighted	Integrated	Integrated	Yes	Wireless	Osram Optotronic , Advance by Signify
Legrand Wattstopper DLM (DLM1)	LMFC-011**	DLM	DLM	Enabled	Enabled	No	Wired	Osram Optotronic , Advance by Signify
Lutron EcoSystem (LH1)	LDE1**	EcoSystem	Quantum, Energi Savr Node, Energi TriPak	Enabled	Enabled	No	Wired	Lutron Hi-Lume
Osram CLM (CLM1)	ZBHA-CLM**	ZigBee HA	Osram ENCELIUM & ENCELIUM EDGE, Daintree Networks	Enabled	Enabled	No	Wireless	Osram Optotronic

*Not all compatible networks may be listed. **For performance data and additional control system details please visit the connected solutions manufacturer websites. Primary drivers are listed in bold. To specify a particular driver please consult factory. †Controls systems supplied by others.