

A brand of **legrand**

Eave™

A kaleidoscope of colors and design options

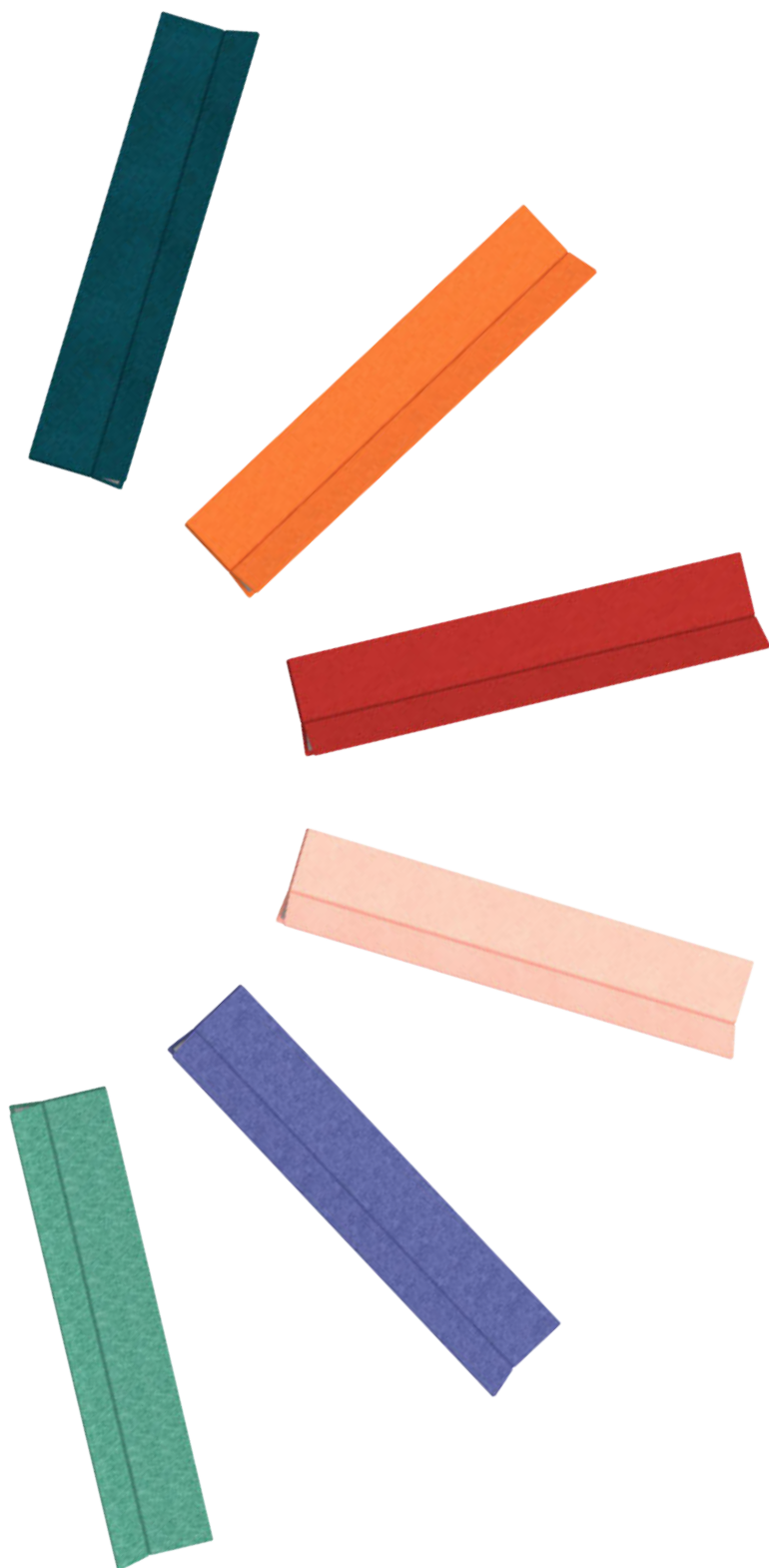

FOCAL POINT®

Eave™

With its simple form factor accentuated by a gentle slope that creates a wider bottom lens opening, Eave is a versatile and comfortable decorative acoustic pendant that will complement a variety of interiors. Made of real wood veneer, the end caps and matching canopies adorn the luminaire with the warmth and subtle woodgrain of rift sawn white oak available in three colorations.

The decorative aspect and performance characteristics of Eave make it a favorite to enhance environments as diverse as commercial offices, schools, libraries, hospitality venues, and any other setting where an appealing luminaire with sound dampening properties is desirable.

- Nominal 11" height
- 3' (direct only), 4', 5' or 6' lengths
- Made of eco-friendly, PET felt material available in a broad color palette
- Real wood end caps and matching wood canopy or painted canopy options
 - White Oak, Amber Oak, Espresso Oak
 - White, Black, Titanium Silver paint
- Aircraft cable suspension with 5" shallow canopy
- Lumen output range:
 - 0-800 lumens per foot indirect
 - 200-700 lumens per foot direct
- Lambertian or wide batwing indirect distribution, Lambertian direct distribution
- Multiple driver options: compatible with several lighting control systems
- Accommodates various ceiling applications: grid, drywall, and open ceilings

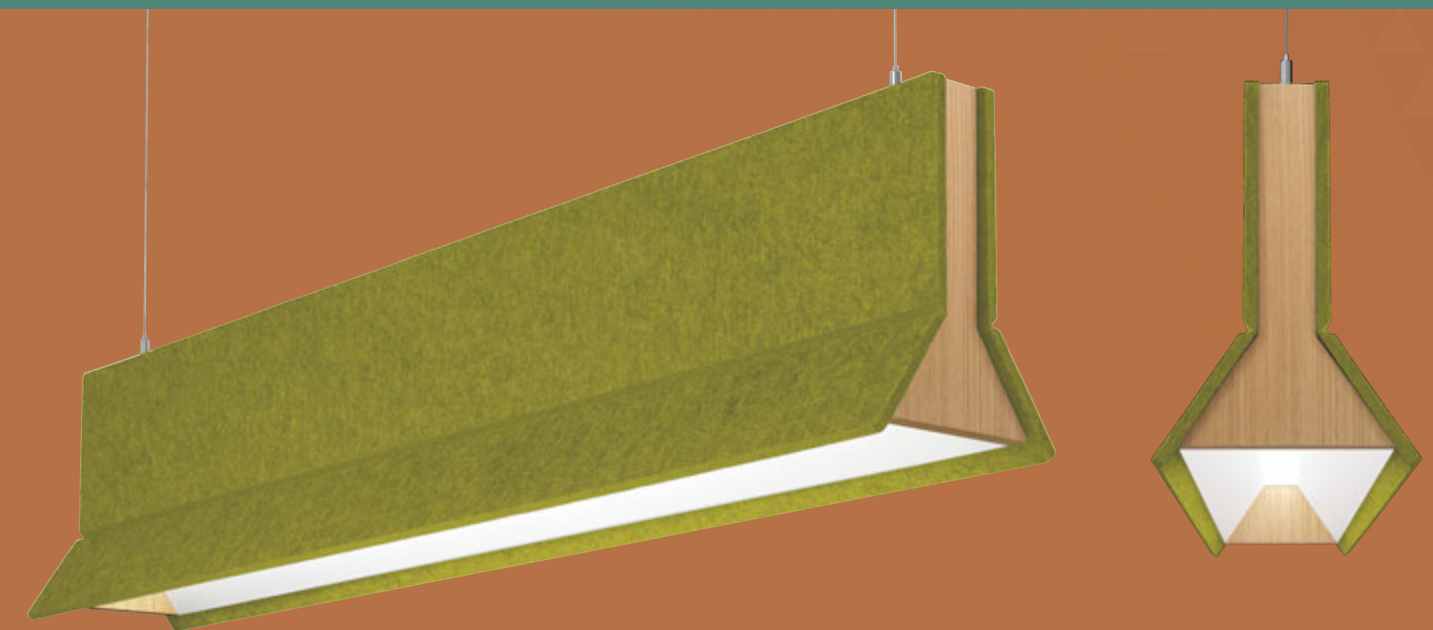
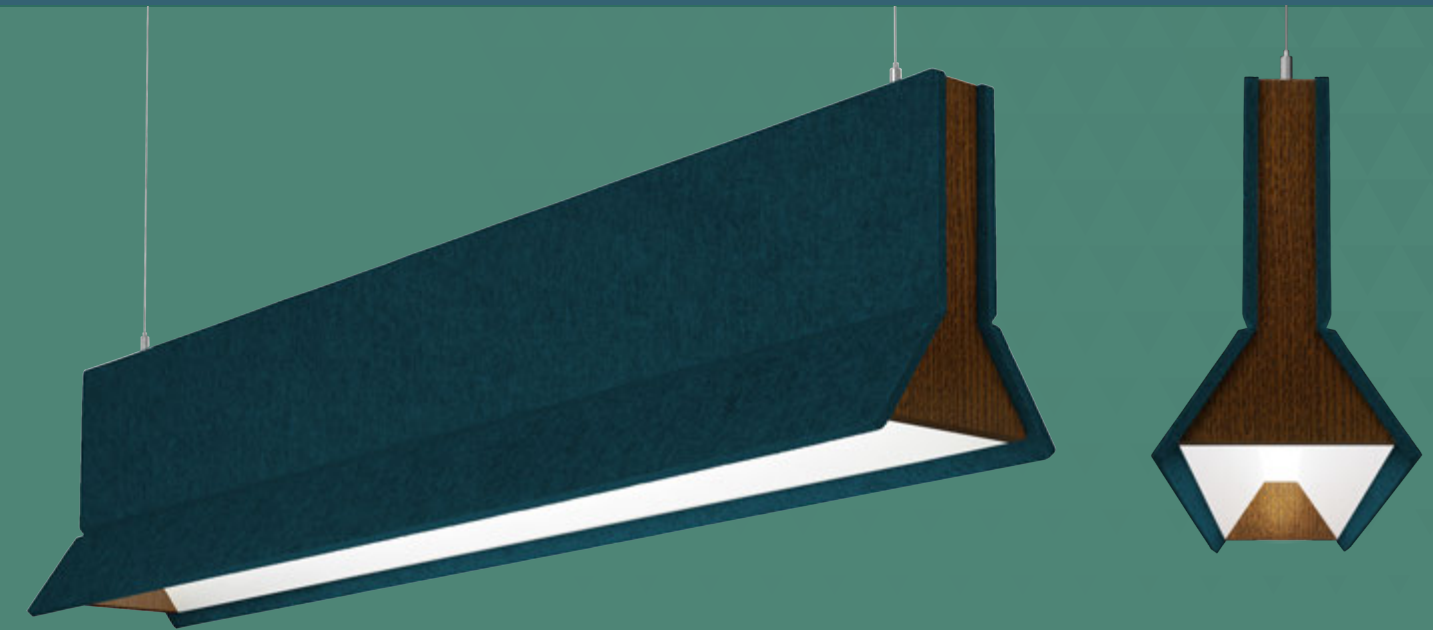
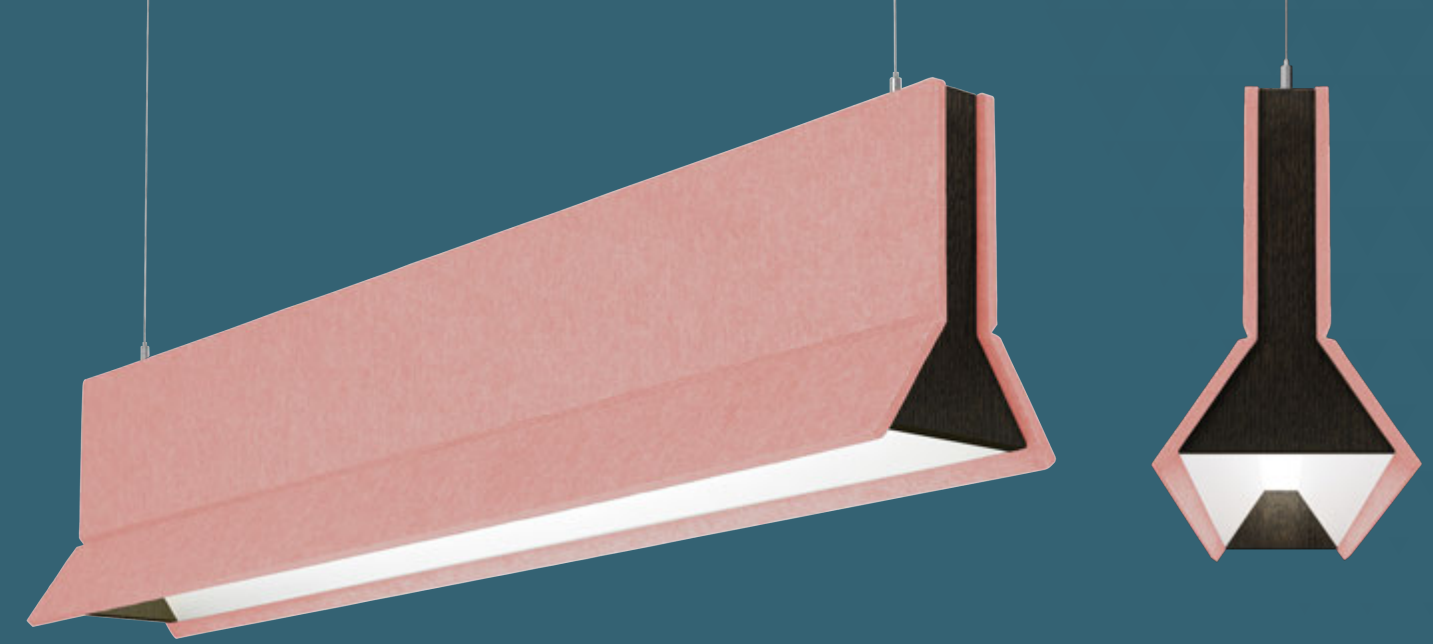
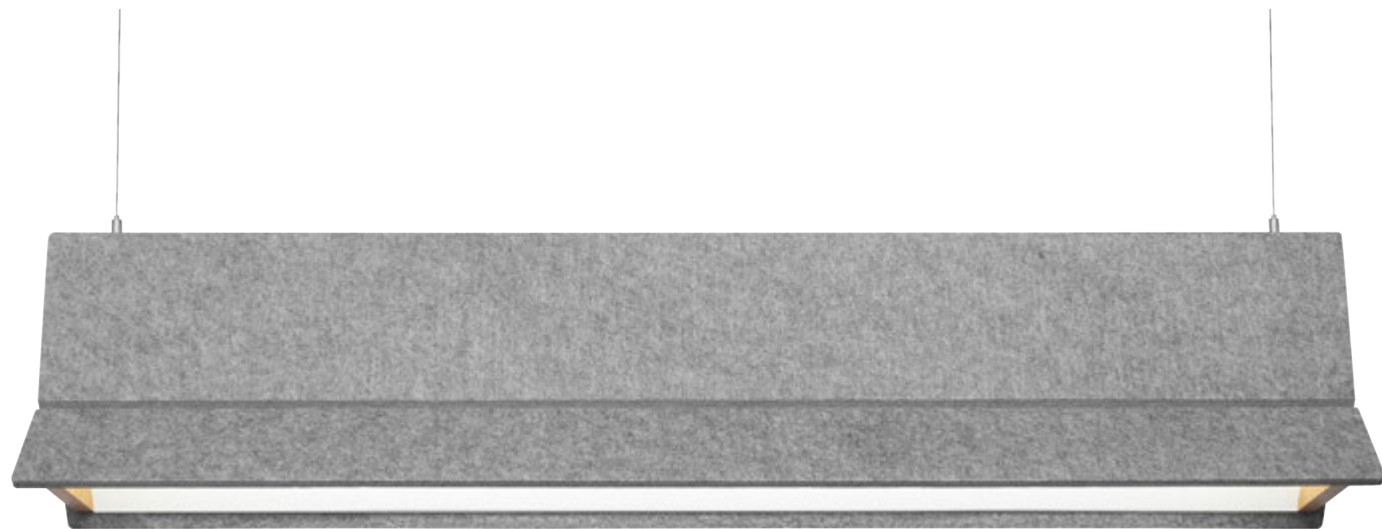



NATURAL
LINEN

CARROT

BLUSH



Appearance

Eave is available in a vast selection of PET felt colors, from neutral to bold, to enhance any environment. Mix and match any acoustic material color with three wood tones available for the end caps and canopies for a differentiated look or opt for white, black or titanium silver painted canopies that will blend into the ceiling.

Built on the same platform as Seem 1 Acoustic and Seem 1 Acoustic Trio, it shares the same nominal baffle width, making it an ideal companion for reception, hospitality and teamwork areas, as well as conference rooms and other spaces where a standalone pendant is desired.

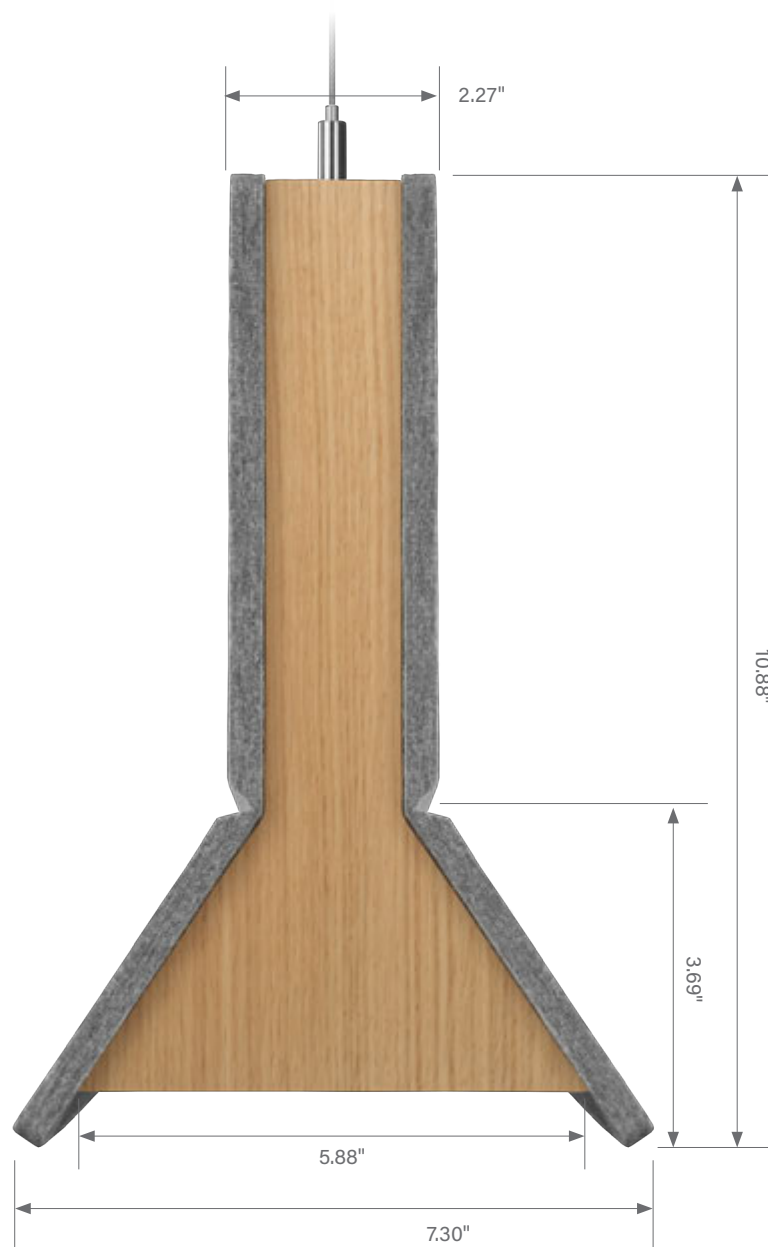

Wood end caps and canopies

Made of rift sawn oak mounted onto 1/4" Medium Density Fiberboard (MDF). The woodgrain runs vertically on the end caps.



Cord Colors



PET Material*

Acoustic material is 100% polyester containing up to 50% recycled plastic bottles (PET) with an ASTM E-84 Class A / CAN ULC S102 fire rating and is moisture resistant. It is Declare Certified, LBC Red List Free. It can be easily cleaned with a soft, lint-free cloth or vacuumed.

Standard Colors

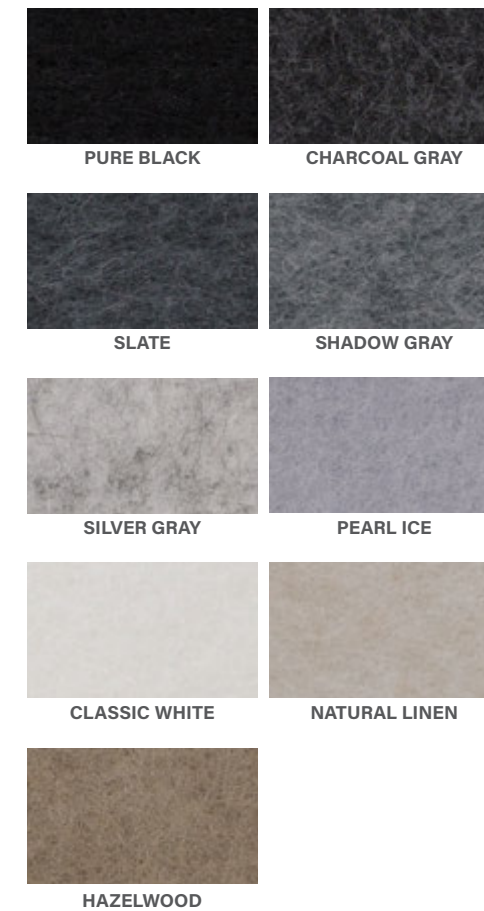

Premium Colors†



Canopy Colors**

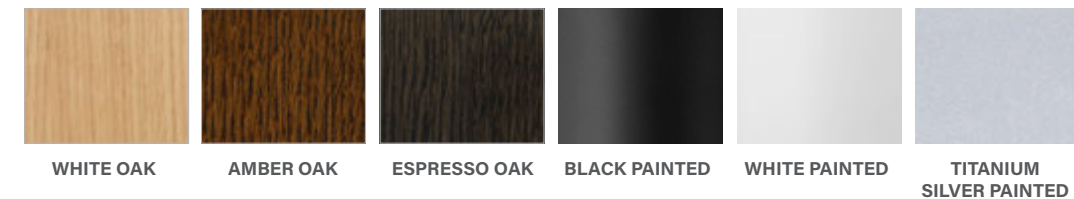

Declare.

9mm PET Felt
Focal Point, LLC

Final Assembly: Chicago, Illinois, USA
Life Expectancy: 30 Years
End of Life Options: Salvageable/Reusable in its Entirety, Recyclable (100%)

Ingredients:
PET; Octadecanamide, N,N'-1,2-ethanediybis; Stearic Acid; Benzenamine, 4-(1-methyl-1-phenylethyl)-N-(4-(1-methyl-1-phenylethyl)phenyl); Benzenepropanoic acid, 3,5-bis(1,1-dimethylethyl)-4-hydroxy-, octadecyl ester; Titanium dioxide

Living Building Challenge Criteria: Compliant

1-13 Red List:
 LBC Red List Free % Disclosed: 100% at 100ppm
 LBC Red List Approved VOC Content: Not Applicable
 Declared

1-10 Interior Performance: CDPH Standard Method v1.1-2010
1-14 Responsible Sourcing: Not Applicable

FPL-0001
EXP: 01 FEB 2022
Original Issue Date: 2020

MANUFACTURER RESPONSIBLE FOR LABEL ACCURACY
INTERNATIONAL LIVING FUTURE INSTITUTE™ living-future.org/declare

*Slight variations in the color of the PET felt should be expected as a result of the manufacturing process. †Contact factory for lead time and pricing.
**Slight variations in color and grain are inherent to the nature of real wood products and should be expected.

LOUNGE



DEEP WATER



Performance

A distinctive decorative acoustic luminaire, Eave also shines thanks to its optical performance that will satisfy the needs of discerning lighting professionals and its sound dampening characteristics.

Optics

Direct only, or independently controlled Indirect/Direct distributions with powerful lumen outputs provide the flexibility to meet the aesthetic and lighting requirements of any application.

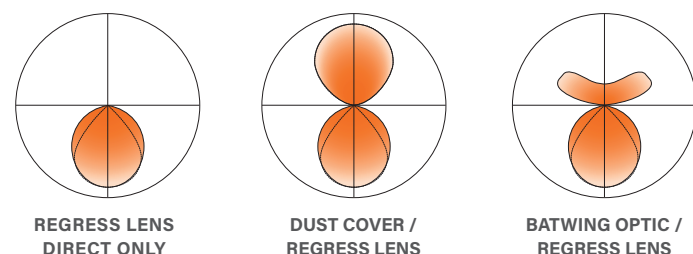

A regressed lens and larger aperture soften the incident luminance and glare, meeting the requirements of the WELL Building Standard™ of 6,000 cd/m² or less between 45° and 90° from nadir. Refer to WELL v2 Feature L04 on the WELL website for more details.

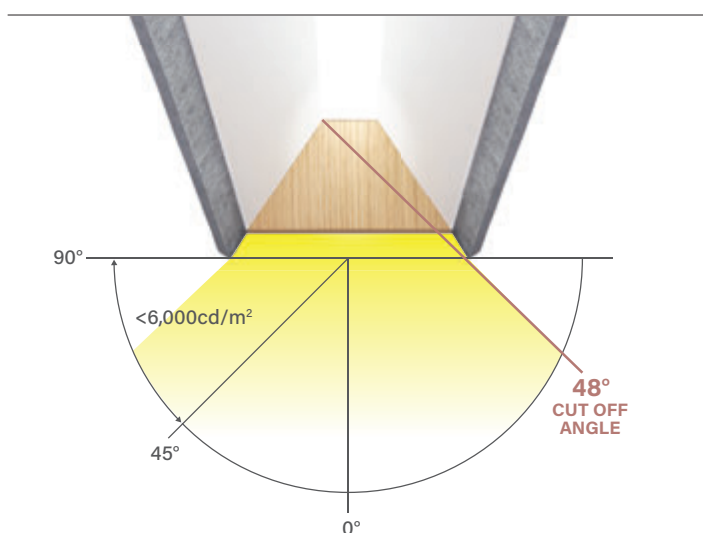

Acoustics

The patent pending, eco-friendly AirCore™ Technology maximizes sound absorption, reduces ecological impact, and provides a lightweight structure for easy installation.

Download the ASTM C423 test reports available at focalpointlights.com for specific acoustic performance data and reach out to our specialists at acoustic.solutions@focalpointlights.com for assistance with acoustic layouts or lighting calculations.

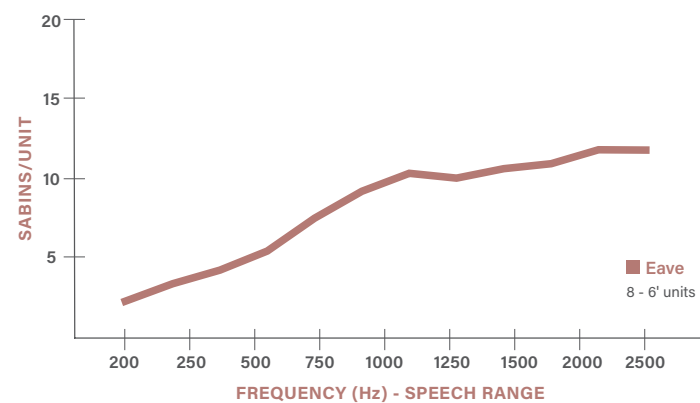

SLATE

OPEN OFFICE



LIME GREEN



FOCAL POINT®

Bringing It All To Light®



©2021 Focal Point, LLC, 4141 S. Pulaski Road, Chicago, IL 60632 | T 773.2479494 | www.focalpointlights.com. All rights reserved. "Focal Point", "Seem", "AirCore", "Eave", "Bringing It All To Light" and the light-ray graphic are trademarks or registered trademarks of Focal Point, LLC. Visit focalpointlights.com for specifications and other details on our entire Focal Point catalog.