

AirCore Blade®

UNLIT ACOUSTIC

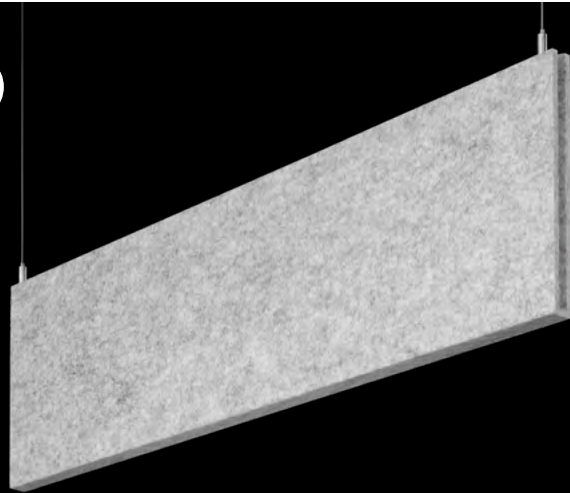

FOCAL POINT®



The Naturals collection - Chestnut/No end cap, Light Oak/White, Cosmic Collection - Moon Rock/Black



DIMENSIONAL DATA

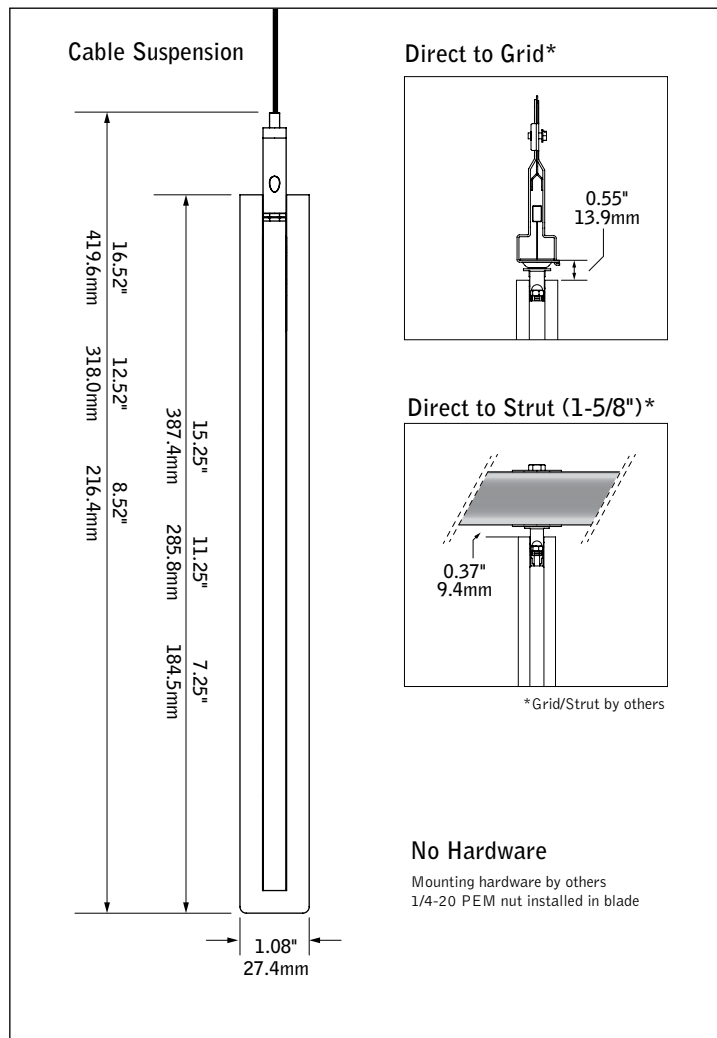

FEATURES

Slim, 1" wide, sound absorbing unlit acoustic blade with optional decorative end cap.

Available in 2' to 8' lengths in 1" increments with 8", 12" or 16" nominal housing heights.

AirCore®: patent pending, eco-friendly technology that maximizes sound absorption and reduces ecological impact.

Acoustic housing available in a wide color palette, ranging from neutral to bold. Available in a range of curated printed finish options, including The Naturals and Cosmic.

Pair with Seem 1 Acoustic luminaires to create a coordinated look within interior spaces.

ACOUSTIC PERFORMANCE

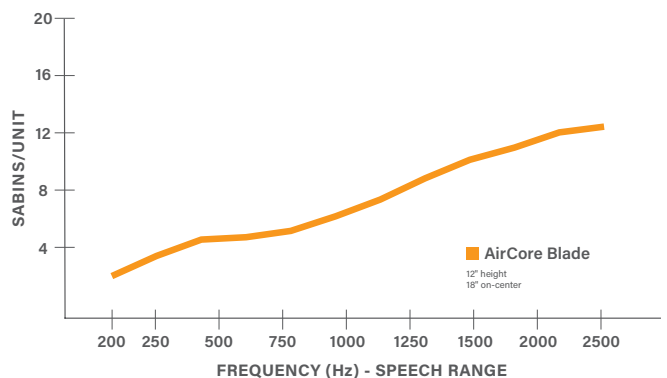

All products were tested in multiple configured arrays. Total absorption will vary based on configuration. Please refer to ASTM C423 reports for more information.

fixture:

project:

MOUNTING DETAILS

Nominal Length	Actual Length (L)*	Suspension Spacing (S)	End of blade to mounting point (E)
2'	24.75"	21.50"	1.625"
3'	36.75"	33.50"	
4'	48.75"	45.50"	
5'	60.75"	57.50"	
6'	72.75"	69.50"	
7'	84.75"	81.50"	
8'	95.00"	91.75"	

No Hardware (NH)
 Mounting hardware by others.
 1/4"-20 PEM nut installed in blade
 *End caps add .2" to overall length.

Thread Engagement Requirements
 Minimum Depth: 0.375"
 Maximum Depth: 0.83"
 (Longer length will extend above the height of blade)

SPECIFICATIONS

Acoustic Material

Content	Housing material is 100% polyester containing up to 50% of recycled plastic bottles (PET felt) and is moisture resistant. See page 3 for color offering. Acoustic material colors are subject to change without notice. For the most current color options, please visit focalpointlights.com/acousticsolutions. Printed finishes such as The Naturals and Cosmic may leave the base material color visible on edges, depending on the product. Consult factory for more information. Lead times may vary depending on color.
Cleaning and Care	Remove dust and debris with a clean, soft, lint-free cloth or vacuum
PET Thickness	9mm
Surface Burning Characteristics	ASTM E84 Class A / CAN ULC S102 Flame Spread: 0 Smoke Development Index: 300
Colorfastness	AATCC 16A Option 3 Class 4 minimum at 40 hours

Acoustic Performance

Acoustic testing is performed on all Focal Point acoustic products and varies based on installation and configuration. ASTM C423 test reports can be downloaded from focalpointlights.com. Contact acoustic.solutions@focalpointlights.com for technical questions.

Sabins	Sabins is a unit of sound absorption. It measures how well one square foot of material absorbs sound. Focal Point has averaged the Sabins per unit at four specific frequency bands representing the human speech range (250, 500, 1000, 2000 Hz) to determine the Sabins per product. 8' length, 12" height: 12" OC = 6.78 Sabins 18" OC = 7.35 Sabins 24" OC = 7.61 Sabins
NRC	Noise Reduction Coefficient (NRC) is the average of how absorptive a material is at various frequencies within the human speech frequency range. Two materials with the same rating may not perform the same in application. Typically, an NRC of 0 indicates perfect reflection, and an NRC of 1 is designated as perfect absorption. However, based on the testing methodology and depending upon the material's shape or surface area products can test at an NRC greater than 1. NRC = 0.90

Labels

Suitable for Dry Locations, indoor use only.

Weight

12" height, 4' length = 5.75lbs. 12" height, 6' length = 8.63lbs. 12" height, 8' length = 11.5lbs.

Finishes - Canopy & Metal End Cap

Polyester powder coat applied over a multi-stage pre-treatment. Canopy white as standard for suspended mounting.

Reliability

At Focal Point, our products are designed to stand the test of time. Each product is engineered using superior components, manufactured with the utmost care and rigorously tested.

Warranty

1-year limited warranty.

ORDERING

Series	AUABS
AirCore Blade	AUABS
Blade Height <small>(heights are nominal)</small>	
8"	8"
12"	12"
16"	16"

Mounting

Suspended

(Mounting hang kits ship with order)

24" Cable Suspension	J24__
48" Cable Suspension	J48__
96" Cable Suspension	J96__
120" Cable Suspension	J120__

(Specify canopy color White (WH), Black (BK) or Titanium Silver (TS). Example: J24WH.)
 (Consult factory for sloped ceiling applications)

Surface Mounted

Direct/Flush to Grid	DTG
Direct/Flush to Strut	DTS

Hardware by others

(Mounting hardware provided by others)

No Hardware	NH
-------------	----

Acoustic Panel Color

See page 3 for color offering

End Caps

No End Caps	NC
Black End Caps	BK
Bronze End Caps	BZ
Titanium Silver End Caps	TS
White End Caps	WH

Blade Length

(Baffles are nominal in length. Baffles cannot be cut to length or joined together in field.)

Specify length in 1" increments
 from 2' to 8' _ft_in



Options in orange qualify for the Quickship program. Five color options. Available in 4', 6', 8' lengths. Maximum linear feet is 200' of acoustic products per order. Refer to Quickship Guide for complete details.

Acoustic Materials



COSMIC (25% SCALE)

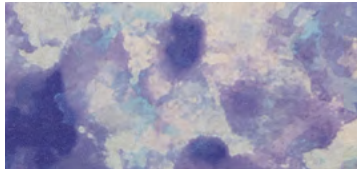

BLUE STAR

BSR



GREEN QUASAR

GQR

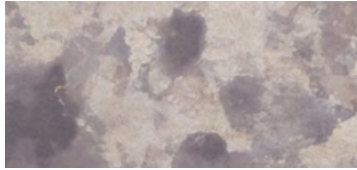

MOON ROCK

MRK

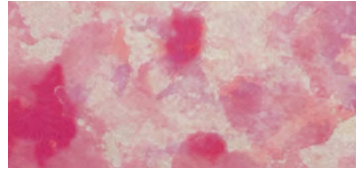

PINK NEBULA

PPN



SOLAR FLARE

SRF

THE NATURALS (25% SCALE)



LIGHT OAK

LOK



GRAY ELM

GRE



CHESTNUT

CHT



WALNUT

WLT

STANDARD PET



PURE BLACK

PBK

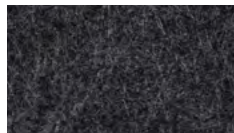

CHARCOAL GRAY

CHG

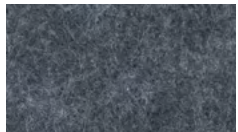

SLATE

SLT

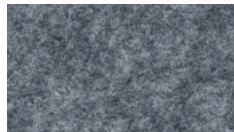

SHADOW GRAY

SDG

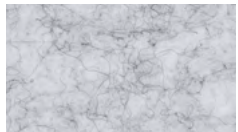

SILVER GRAY

SLG

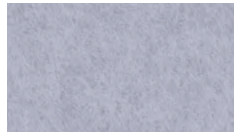

PEARL ICE

PIC

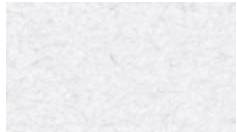

CLASSIC WHITE

CWH

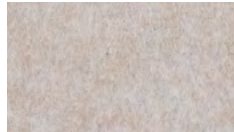

NATURAL LINEN

NTL

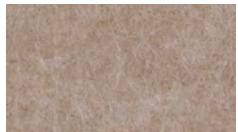

HAZELWOOD

HZW

PREMIUM PET



CORNFLOWER BLUE

CFB



DENIM BLUE

DNB

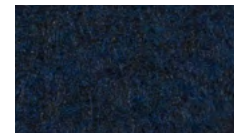

MIDNIGHT BLUE

MNB

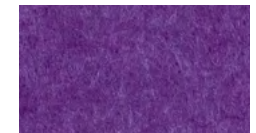

DEEP PURPLE

DPP

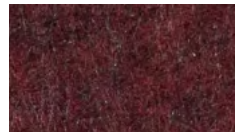

BRICK RED

BRD



CHERRY RED

CHR

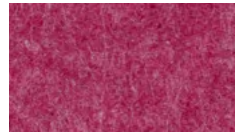

BERRY

BRY



BLUSH

BLS



CARROT

CRT



PINEAPPLE

PNA

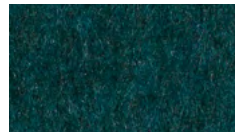

DEEP WATER

DWT



SEAFOAM

SFM



EMERALD GREEN

EMG

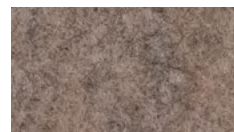

LIMESTONE

LMS

Slight color variations are inherent to the PET felt manufacturing process. Color renditions on screens vary due to display settings and lighting conditions.

Order samples at focalpointlights.com/Samples

Declare.

PET
Focal Point, LLC

Final Assembly: Chicago, Illinois, USA
Life Expectancy: 30 Year(s)
End of Life Options: Salvageable/Reusable in its Entirety, Recyclable (100%)

Ingredients:

Polyethylene terephthalate; PET; N, N'-Ethylene bisstearamide; Octadecanamide, N,N'-1,2-ethanediybis-; Stearic Acid; Antioxidant 1076; Benzenepropanoic acid, 3,5-bis(1,1-dimethylethyl)-4-hydroxy-, octadecyl ester; Antioxidant KY-405; Benzenamine, 4-(1-methyl-1-phenylethyl)-N-(4-(1-methyl-1-phenylethyl)phenyl); Titanium Dioxide; Titanium dioxide

Living Building Challenge Criteria:

I-13 Red List:

- LBC Red List Free % Disclosed: 100% at 100ppm
- LBC Red List Approved VOC Content: Not Applicable
- Declared

I-10 Interior Performance: Not Compliant
I-14 Responsible Sourcing: Not Applicable

FPL-0001
EXP: 01 JUN 2026
Original Issue Date: 2020

© 2020 Focal Point, LLC. All rights reserved. Focal Point, LLC is a member of the International Living Future Institute™ living-futures.org/declare