

Seem® 4

LED DIRECT/INDIRECT WALL MOUNT

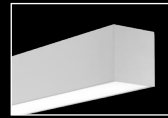

flush lens
top & bottom

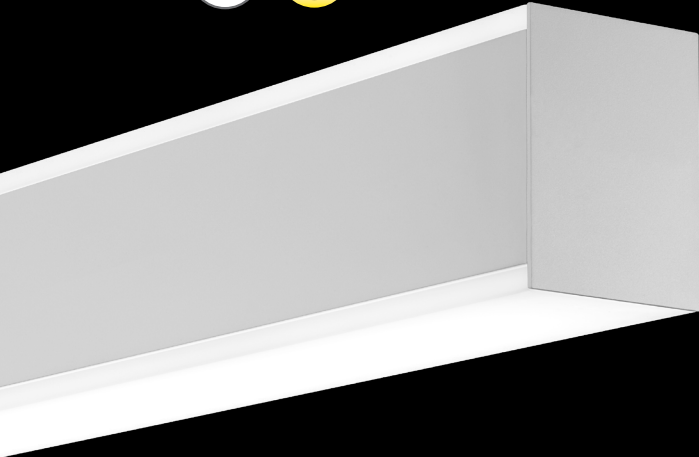
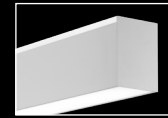

0.5" pop-up lens /
flush lens bottom

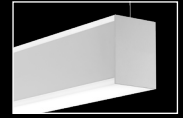

linear suspended
companion

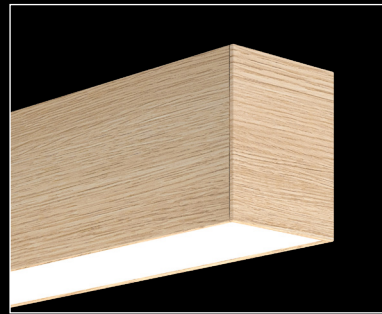

The Naturals collection - Light Oak shown

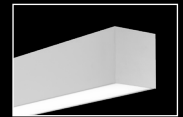

direct only
companion



wall to ceiling
corner companion

DIMENSIONAL DATA

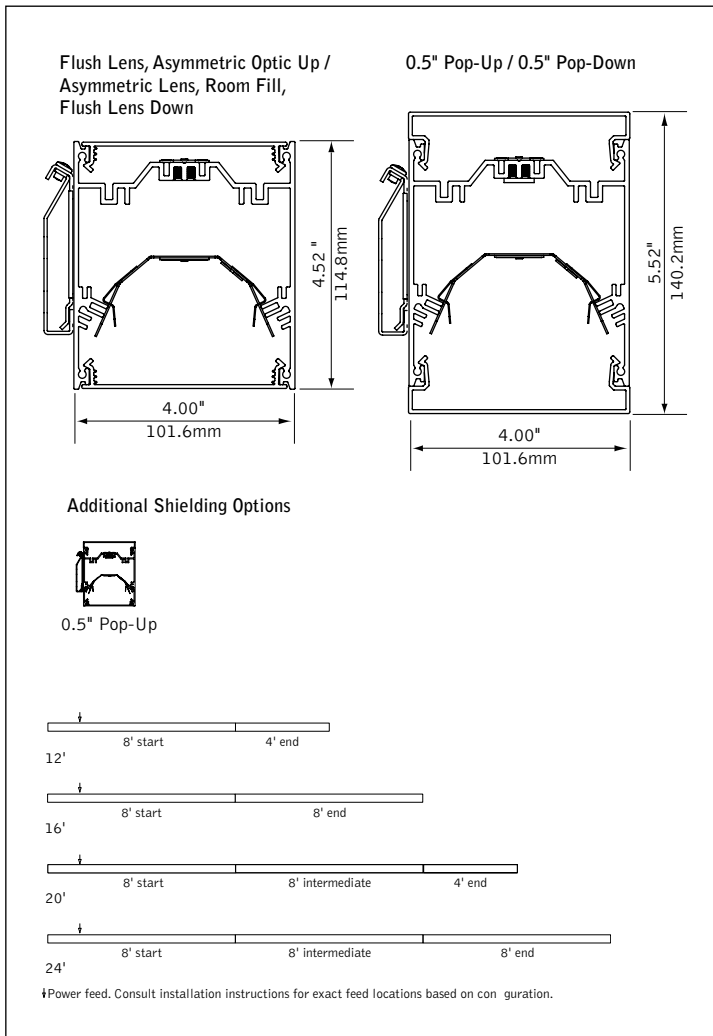

FEATURES

- Narrow extruded aluminum 4" direct/indirect wall mount LED Pop-lens options.
- Individual units and continuous runs in 1' increments.
- Frosted acrylic lenses provide uninterrupted illumination, without pixels or shadows.
- LED position and lens material optimized to provide the perfect blend of high performance and visual comfort.
- Choice of output levels and light distributions to meet a wide variety of application needs.
- PoE compatible: Integrates with Power over Ethernet lighting systems via standard, low-voltage wires.
- Tunable White: Supports human activity, well-being, and preferences with a light quality that evolves throughout the day.
- Available with The Naturals, a series of finishes that exude biophilic beauty.

PERFORMANCE

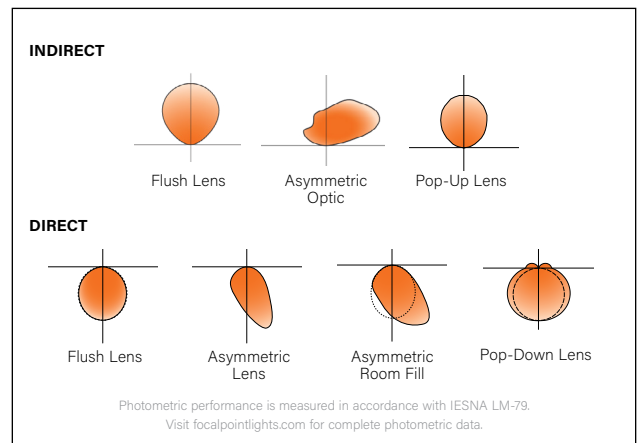

DETAILS

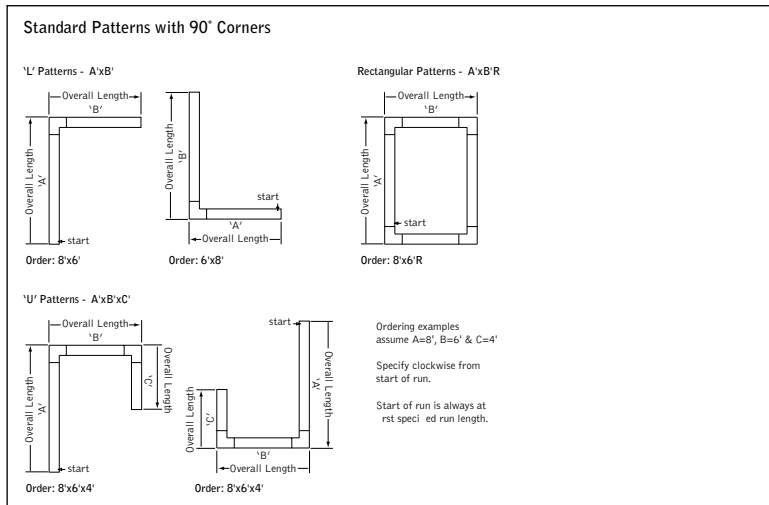

DIRECT ASYMMETRIC
Standard Application Example

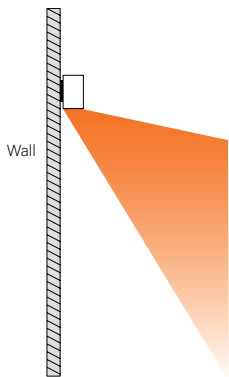

DIRECT ASYMMETRIC ROOM FILL
Standard Application Example

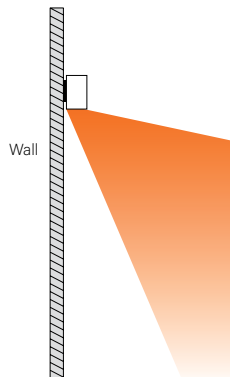

Asymmetric Room Fill Lens

The asymmetric room fill optic projects light into the space to evenly illuminate horizontal planes. It is ideal to light rooms and corridors from the perimeter, resulting in superior efficacy and uniformity on the floor.

STANDARD WHITE

Luminaire Series

Seem 4 Direct/Indirect LED FSM4BW

Shielding

(Combine Indirect and Direct options to create a single code.)

Indirect/Top Shielding Options

- Asymmetric Optic AS
- Flush Lens FL
- 0.5" Pop-Up Lens PU

Direct/Bottom Shielding Options

- Asymmetric Lens AS
- Asymmetric Room Fill AF
- Flush Lens Bottom FL
- 0.5" Pop-Down Bottom PD05

Direct Distribution

- 275 Lumens per foot 275DN
- 375 Lumens per foot 375DN
- 625 Lumens per foot 625DN
- 875 Lumens per foot 875DN
- 1000 Lumens per foot* 1000DN
- 1125 Lumens per foot* 1125DN
- 1250 Lumens per foot* 1250DN

*(Not available with Pop Down Lens)

Indirect Distribution

- 275 Lumens per foot 275UP
- 375 Lumens per foot 375UP
- 625 Lumens per foot 625UP
- 875 Lumens per foot 875UP
- 1000 Lumens per foot 1000UP
- 1125 Lumens per foot* 1125UP
- 1250 Lumens per foot* 1250UP

*(Not available with Pop-Up or Pop-Down Lenses)

Color Temperature

- 2700K, 80+ CRI or 2700K, 90+ CRI 27K or 927K
- 3000K, 80+ CRI or 3000K, 90+ CRI 30K or 930K
- 3500K, 80+ CRI or 3500K, 90+ CRI 35K or 935K
- 4000K, 80+ CRI or 4000K, 90+ CRI 40K or 940K

Circuits & Zones

- 1 Circuit, non-emergency 1C
- 2 non-emergency circuits provide independent control of Direct and Indirect sources 2C

Consult Ordering Guide on page 4 for multiple circuiting and zoning options

Voltage

- 120/277 UNV Volt UNV
- Low Voltage LV

Control System & Dimming Level

- 0-10V - 10% Dimming LD1
- 0-10V - 1% Dimming L11
- Low Voltage, PoE compatible LVN
- (No driver. Not available with EM or EC. LV Voltage only.)
- Lutron Hi-Lume EcoSystem (LDE1) - 1% Dimming LH1
- DALI - 1% Dimming D11
- (625 lumens per foot max.)

Mounting

- Wall Mount WM

Factory Options

(See Ordering Guide on page 4 for ordering details for DC, EC, EM & ECD.)

- Daylight Circuit _DC

- Emergency Circuit _EC

- Emergency Battery Pack† _EM

- Emergency Control Device† _ECD

†(4' minimum. 120/277 Volt Only. EM or ECD not available at corners.)

Finish

(See finishes page for The Naturals options)

- Black BK

- Titanium Silver TS

- Matte White Housing WH

Luminaire Length

(3' minimum length. Leave blank for patterns. Lengths are nominal)

- Specify luminaire/row length in ' increments X'

(Smaller increments available. Consult factory.)

Pattern Options

- 'L' pattern (5' minimum length) A' x B'
- 'U' pattern (7' minimum length) A' x B' x C'
- Rectangular pattern (7' minimum length) A' x B'R

(Consult factory for other pattern options)



Options in orange qualify for the Quickship program. Run lengths in ' increments, 1000' total. Refer to Quickship Guide for complete details.

DETAILS

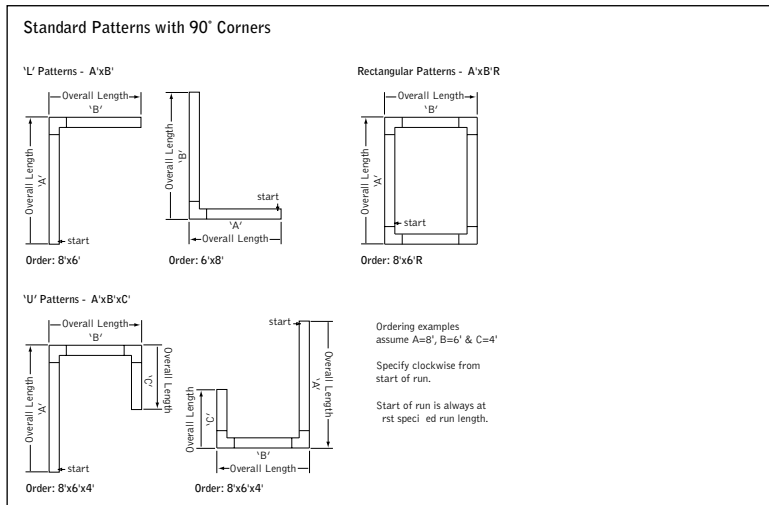

SPECIFICATIONS

LED System

Proprietary linear LED module incorporates premium LEDs on a robust platform to achieve excellent thermal management. LEDs are placed to promote a uniform appearance. Available in 3000K, 3500K or 4000K with >80 or 90 CRI, 3 SDCM or Tunable White (2700K-6500K), CRI>80, >90. 3500K and 4000K with CRI>90 have a cyanosis observation index (COI) of 3.3 or less. LED modules and drivers are replaceable from below.

Construction

One piece extruded aluminum housing. Die cast aluminum end caps.
3' unit weight: 14.5lbs., 4' unit weight: 19lbs., 5' unit weight: 25lbs.

Optic

Reflectors fabricated of 22 Ga. steel finished in High Reflectance White powder coat. Extruded acrylic lens .085" thick with satin finish, up to 8' continuous.

Electrical

Luminaires are pre-wired with factory installed branch circuit wiring and over-molded quick connects. Standard 120-277V constant current driver includes 0-10V analog dimming. Dimming range 100% to 10%. Power factor > .9. PoE compatible: Integrates with Power over Ethernet lighting systems via standard, low-voltage wires. PoE runs require an independent PoE node and power feed for each luminaire section.

Emergency Battery

Bodine BSL310LP. Emergency output - 10 watts for 90 minutes.
Maximum mounting height: 14.12ft

Labels

UL and cUL listed. Suitable for Dry or Damp Locations, indoor use only.

Finish

Polyester powder coat applied over a multi-stage pre-treatment. The Naturals: 100% low VOC vinyl.

Lumen Maintenance

Reported: L70 at >61,000 hours Calculated: L70 at 395,000 hours
Reported: L90 at >61,000 hours Calculated: L90 at 100,000 hours
Derived from EPA TM-21 calculator. Based on typical conditions, consult factory for additional data.

Reliability

At Focal Point, our products are designed to stand the test of time. Each luminaire is engineered using superior components, manufactured with the utmost care and rigorously tested. Contact us for reliability data.

Warranty

LED system rated for operation in ambient environments up to 25°C. 5 year limited warranty.



TUNABLE WHITE

Luminaire Series

Seem 4 Direct/Indirect LED **FSM4BW**

Shielding

(Combine Indirect and Direct options to create a single code.)

Indirect/Top Shielding Options | Flush Lens FL
0.5" Pop-Up Lens PU

Direct/Bottom Shielding Options | Flush Lens Bottom FL
0.5" Pop-Down Bottom PD05

Direct Distribution

275 Lumens per foot 275DN
(4' min with FLFL or PUFL)
375 Lumens per foot 375DN
625 Lumens per foot 625DN
875 Lumens per foot 875DN
1000 Lumens per foot* 1000DN
1125 Lumens per foot* 1125DN

*(Not available with Pop Down Lens)

Indirect Distribution

275 Lumens per foot 275UP
375 Lumens per foot 375UP
625 Lumens per foot 625UP
875 Lumens per foot 875UP
1000 Lumens per foot 1000UP
1125 Lumens per foot 1125UP

(Not available with Pop-Up or Pop-Down lenses)

Color Temperature

Tunable White: 2700-6500K, 80+ CRI 2765T
Tunable White: 2700-6500K, 90+ CRI 92765T

Circuits & Zones

1 Circuit, non-emergency 1C
2 non-emergency circuits provide independent control of Direct and Indirect sources 2C
Consult Ordering Guide for multiple circuiting and zoning options _C_Z_DL

Voltage

120/277 UNV Volt UNV

Control System & Dimming Level

DALI - 1% Dimming D1TW
(Default driver offers DT6 control. It requires two addresses, one for intensity & one for CCT tuning. Consult factory for DT8. Extended lead time applies.)

Mounting

Wall Mount WM

Factory Options

(See Ordering Guide on page 4 for ordering details for DC, EC, EM & ECD.)

Daylight Circuit _DC

Emergency Circuit _EC

Emergency Battery Pack† _EM

Emergency Control Device† _ECD

†(Consult factory)

Finish

(See finishes page for The Naturals options)

Black BK

Titanium Silver TS

Matte White Housing WH

Luminaire Length

(3' minimum length. Leave blank for patterns. Lengths are nominal)

Specify luminaire/row length in 1' increments X'

(Smaller increments available. Consult factory.)

Pattern Options













'L' pattern (5' minimum length) A' x B'

'U' pattern (7' minimum length) A' x B' x C'

Rectangular pattern (7' minimum length) A' x B'R

(Consult factory for other pattern options)





4' PERFORMANCE CHART

Direct Distribution	Indirect Distribution	Distribution % (Direct/Indirect)	Total Nominal Lumens	Tested System Watts	Lumens Per Watt (LPW)									Tested System Watts	Lumens Per Watt (LPW)		
																	
275DN	275	50/50	2200	18.2	121	121	117	122	122	118	113	113	109	21.2	106	106	100
	375	42/58	2600	20.8	128	128	124	125	125	121	116	116	112	23.8	113	110	104
	625	31/69	3600	27.9	135	135	132	130	130	127	115	115	112	30.9	123	119	106
	875	24/76	4600	36.0	134	134	132	129	129	126	113	113	112	39.0	124	120	107
	1000	22/78	5100	40.0	134	134	132	129	129	127	115	115	113	43.0	125	120	108
	1125	20/80	5600	44.0	134	134	132	128	128	127	—	—	—	47.0	126	121	—
	1250	18/82	6100	46.9	136	136	134	129	129	127	—	—	—	49.9	128	122	—
375DN	275	58/42	2600	21.2	125	125	120	126	126	121	118	118	113	25.4	104	105	99
	375	50/50	3000	23.8	131	131	126	128	128	123	120	120	115	28.0	111	109	103
	625	38/62	4000	30.9	137	137	133	132	132	129	118	118	115	35.1	120	116	105
	875	30/70	5000	39.0	135	135	132	130	130	127	116	116	113	43.2	122	117	106
	1000	27/73	5500	43.0	135	135	133	130	130	128	117	117	114	47.1	123	118	108
	1125	25/75	6000	47.0	135	135	132	130	130	127	—	—	—	51.2	124	119	—
	1250	23/77	6500	49.9	137	137	134	130	130	128	—	—	—	54.1	126	120	—
625DN	275	69/31	3600	30.1	124	124	118	125	125	119	119	119	113	38.5	98	98	95
	375	63/37	4000	32.6	128	128	123	126	126	121	120	120	115	41.1	102	101	97
	625	50/50	5000	39.8	133	133	129	130	130	125	118	118	114	48.2	110	108	100
	875	42/58	6000	47.8	133	133	129	129	129	125	117	117	113	56.3	113	110	102
	1000	38/62	6500	51.8	133	133	129	129	129	125	117	117	114	60.2	115	111	103
	1125	36/64	7000	55.9	133	133	129	129	129	125	—	—	—	64.3	116	112	—
	1250	33/67	7500	58.8	134	134	131	129	129	126	—	—	—	67.2	118	113	—
875DN	275	76/24	4600	39.1	123	123	116	124	124	117	119	119	113	49.3	97	97	95
	375	70/30	5000	41.7	127	126	120	125	125	118	120	120	114	51.9	101	100	97
	625	58/42	6000	48.8	131	131	125	128	128	122	119	119	114	59.0	108	106	100
	875	50/50	7000	56.9	131	131	126	127	127	123	117	117	113	67.1	110	108	101
	1000	47/53	7500	60.8	131	131	127	127	127	123	118	118	114	71.0	112	109	102
	1125	44/56	8000	64.9	131	131	127	127	127	123	—	—	—	75.1	113	110	—
	1250	41/59	8500	67.8	132	132	128	128	128	124	—	—	—	78.0	115	111	—
1000DN	275	78/22	5100	43.7	122	122	115	123	123	116	119	119	112	—	—	—	—
	375	73/27	5500	46.2	125	125	119	124	124	117	119	119	113	—	—	—	—
	625	62/38	6500	53.4	129	129	124	127	127	121	118	118	113	—	—	—	—
	875	53/47	7500	61.4	129	129	124	126	126	121	117	117	112	—	—	—	—
	1000	50/50	8000	65.4	130	130	125	126	126	122	117	117	113	—	—	—	—
	1125	47/53	8500	69.5	130	130	125	126	126	122	—	—	—	—	—	—	—
	1250	44/56	9000	72.4	131	131	127	127	127	123	—	—	—	—	—	—	—
1125DN	275	80/20	5600	48.3	121	120	114	122	121	114	118	117	111	—	—	—	—
	375	75/25	6000	50.9	124	123	117	123	122	116	119	118	112	—	—	—	—
	625	64/36	7000	58.0	128	127	122	126	125	120	118	117	112	—	—	—	—
	875	56/44	8000	66.0	128	128	123	125	125	120	117	116	112	—	—	—	—
	1000	53/47	8500	70.0	129	128	124	125	125	120	117	117	113	—	—	—	—
	1125	50/50	9000	74.1	129	128	124	125	125	121	—	—	—	—	—	—	—
	1250	47/53	9500	77.0	130	130	126	126	126	122	—	—	—	—	—	—	—
1250DN	275	82/18	6100	52.1	121	120	113	121	120	114	118	117	111	—	—	—	—
	375	77/23	6500	54.7	123	123	116	122	121	115	118	118	112	—	—	—	—
	625	67/33	7500	61.8	127	126	121	125	124	119	118	117	112	—	—	—	—
	875	59/41	8500	69.9	127	127	122	125	124	119	116	116	111	—	—	—	—
	1000	56/44	9000	73.8	128	127	123	125	124	120	117	116	112	—	—	—	—
	1125	53/47	9500	77.9	128	127	123	125	124	120	—	—	—	—	—	—	—
	1250	50/50	10000	80.8	129	129	124	126	125	121	—	—	—	—	—	—	—

*Based on 3500K, 4' lengths. *Lumen output may vary +/- 5%. Actual wattage may vary +/- 5%. Pop-Up Lens/Pop-down lens lumen output may vary +/- 5%



4' PERFORMANCE CHART

Direct Distribution	Indirect Distribution	Distribution % (Direct/Indirect)	Total Nominal Lumens	Tested System Watts	Lumens Per Watt (LPW)		Lumens Per Watt (LPW)		Lumens Per Watt (LPW)		Lumens Per Watt (LPW)	
					 FLFL	Tested System Watts	 PUFL	Tested System Watts	 FLPD05	Tested System Watts	 PUPD05	Tested System Watts
275DN	275	50/50	2200	24.5	90	26.3	84	28.1	78	29.9	74	
	375	42/58	2600	28.7	91	30.3	86	32.3	81	33.8	77	
	625	31/69	3600	37.8	96	40.8	89	41.4	87	44.4	81	
	875	24/76	4600	46.1	100	51.8	89	49.7	93	55.4	83	
	1000	22/78	5100	52.4	98	57.0	90	56.0	91	60.6	84	
	1125	20/80	5600	57.0	99	—	—	60.6	93	—	—	
375DN	275	58/42	2600	28.5	91	30.3	86	33.4	77	35.2	74	
	375	50/50	3000	32.7	92	34.2	88	37.6	80	39.2	76	
	625	38/62	4000	41.8	96	44.8	90	46.8	86	49.8	80	
	875	30/70	5000	50.1	100	55.8	90	55.0	91	60.8	82	
	1000	27/73	5500	56.4	98	61.0	90	61.4	90	65.9	83	
	1125	25/75	6000	61.0	99	—	—	65.9	91	—	—	
625DN	275	69/31	3600	38.8	93	40.6	89	46.0	78	47.8	75	
	375	63/37	4000	43.0	93	44.6	90	50.2	80	51.8	77	
	625	50/50	5000	52.2	96	55.1	91	59.3	84	62.3	80	
	875	42/58	6000	60.4	99	66.2	91	67.6	89	73.3	82	
	1000	38/62	6500	66.8	98	71.3	91	73.9	88	78.5	83	
	1125	36/64	7000	71.3	98	—	—	78.5	89	—	—	
875DN	275	76/24	4600	47.7	96	49.5	93	61.7	75	63.5	73	
	375	70/30	5000	51.9	96	53.5	93	65.9	76	67.5	74	
	625	58/42	6000	61.0	98	64.0	94	75.1	80	78.0	77	
	875	50/50	7000	69.3	101	75.0	93	83.3	84	89.1	79	
	1000	47/53	7500	75.6	99	80.2	93	89.7	84	94.2	80	
	1125	44/56	8000	80.2	100	—	—	94.2	85	—	—	
1000DN	275	78/22	5100	54.6	93	56.4	90	—	—	—	—	
	375	73/27	5500	58.8	94	60.4	91	—	—	—	—	
	625	62/38	6500	67.9	96	70.9	92	—	—	—	—	
	875	53/47	7500	76.2	98	82.0	92	—	—	—	—	
	1000	50/50	8000	82.5	97	87.1	92	—	—	—	—	
	1125	47/53	8500	87.1	98	—	—	—	—	—	—	
1125DN	275	80/20	5600	59.9	93	61.7	91	—	—	—	—	
	375	75/25	6000	64.1	94	65.7	91	—	—	—	—	
	625	64/36	7000	73.3	95	76.3	92	—	—	—	—	
	875	56/44	8000	81.5	98	87.3	92	—	—	—	—	
	1000	53/47	8500	87.9	97	92.4	92	—	—	—	—	
	1125	50/50	9000	92.4	97	—	—	—	—	—	—	

*Based on 2700k, 80CRI, 4' lengths. *Lumen output may vary +/- 5%. Actual wattage may vary +/- 5%. Pop-Up Lens/Pop-down lens lumen output may vary +/- 5%

Lumen Multipliers

CRI	Multiplier
80+	1.00
90+	0.89

Wattage Multipliers

CCT	Multiplier
2700K	1.00
3000K	0.92
3500K	0.88
4000K	0.86
5000K	0.85
5700K	0.87
6500K	0.90

Finishes



STANDARD FINISHES



WHITE WH BLACK BK TITANIUM SILVER TS

THE NATURALS (25% SCALE)

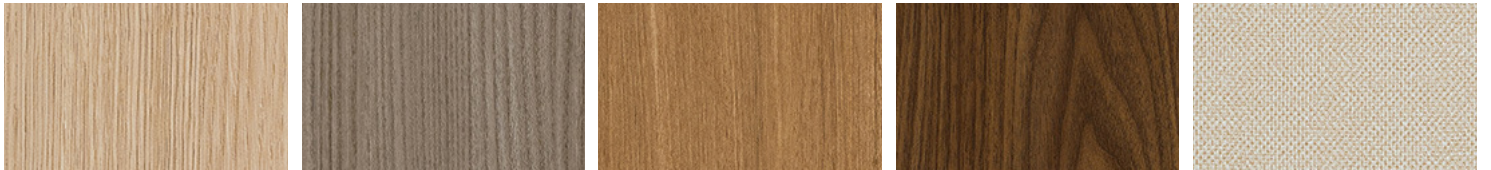

LIGHT OAK LOK GRAY ELM GRE CHESTNUT CHT WALNUT WLT WOVEN LINEN WLN