

Seem® 1

LED DIRECT/INDIRECT WALL MOUNT

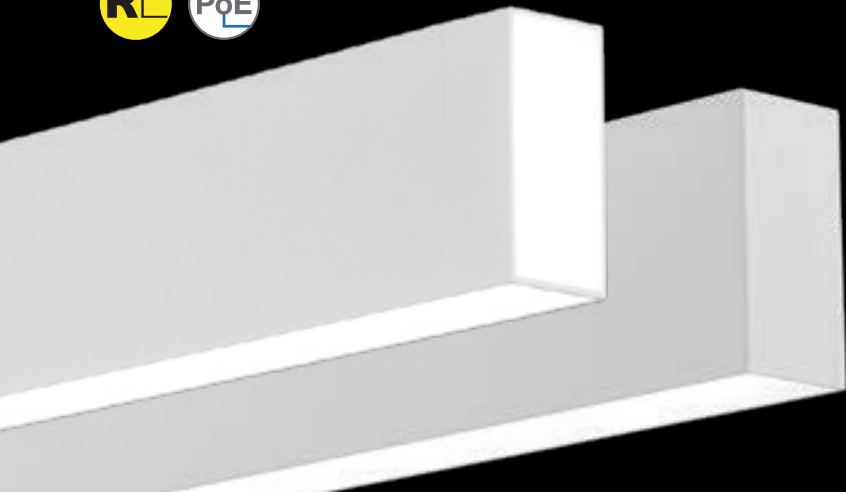

Pop-Down Lens



Corner detail

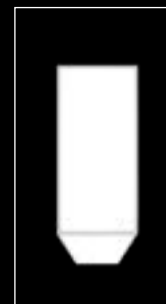

lit end cap detail



The Naturals collection - Chestnut shown

DIMENSIONAL DATA

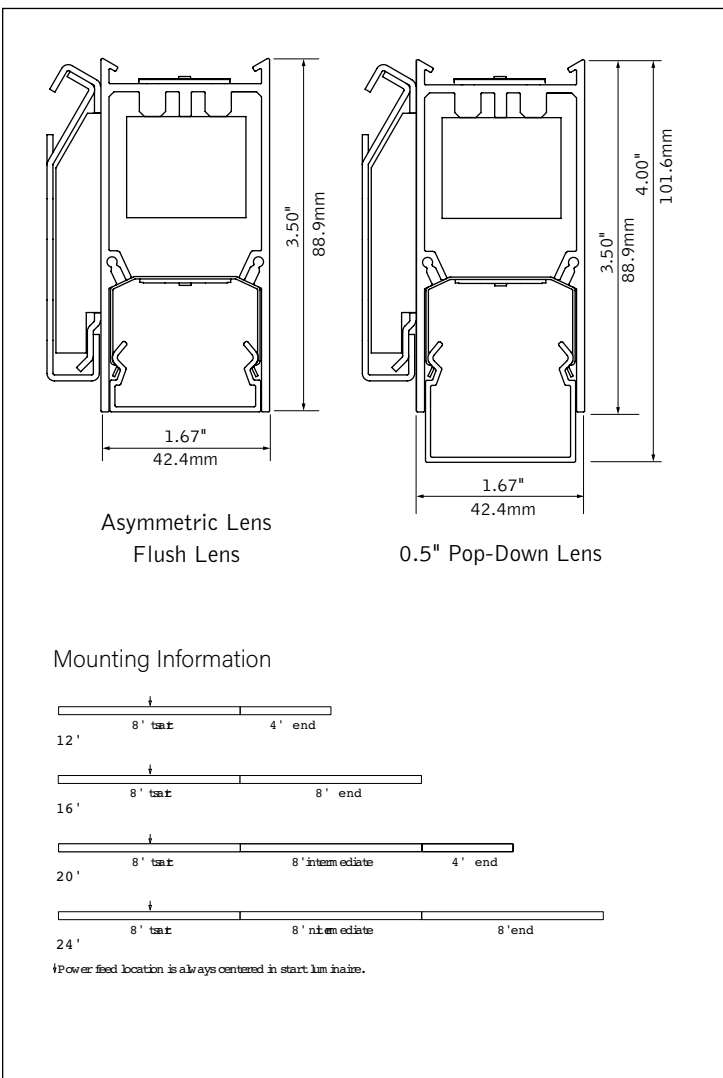

FEATURES

- Narrow extruded aluminum 1.5" linear direct/indirect wall mount LED with multiple shielding options.
- Individual units and continuous runs in 1" increments.
- Frosted acrylic lens provides uninterrupted illumination, without pixels or shadows.
- LED position and lens material optimized to provide the perfect blend of high performance and visual comfort.
- Choice of output levels to meet a wide variety of application needs.
- PoE compatible: Integrates with Power over Ethernet lighting systems via standard, low-voltage wires.
- Available with The Naturals, a series of finishes that exude biophilic beauty.

DISTRIBUTIONS

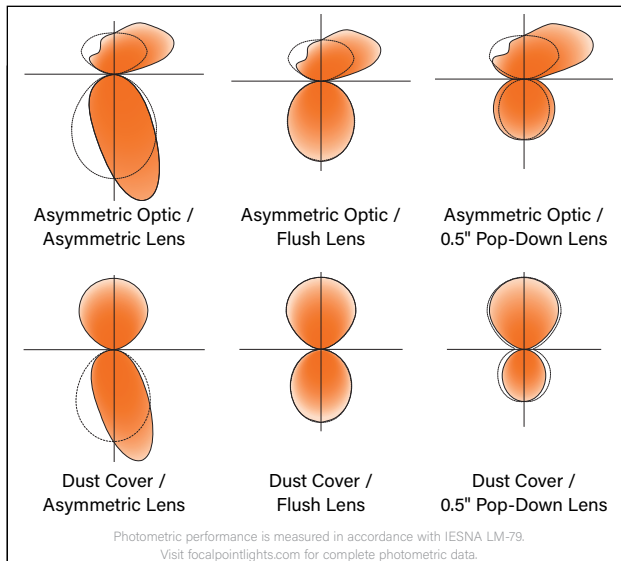

DETAILS

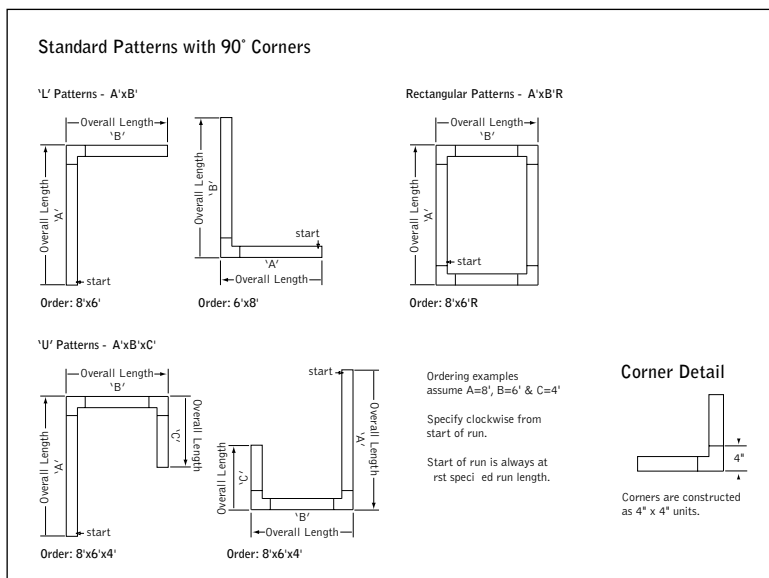

SPECIFICATIONS

LED System

Proprietary linear LED module incorporates premium LEDs on a robust platform to achieve excellent thermal management. LEDs are placed to promote a uniform appearance. Available in 3000K, 3500K or 4000K with both 80 and 90 CRI options. 3500K and 4000K with CRI>90 have a cyanosis observation index (COI) of 3.3 or less. LED modules and drivers are replaceable from below. Color accuracy <3 SDCM.

Construction

One piece extruded aluminum housing. Cast aluminum end caps. 8' unit weight: 15lbs.

Optic

Reflectors fabricated of 22 Ga. steel finished in High Reflectance White powder coat. Extruded acrylic lens .07" thick with frosted finish, up to 8' continuous.

Electrical

Luminaires are pre-wired with factory installed branch circuit wiring and over-molded quick connects. Standard 120-277V constant current driver includes 0-10V analog dimming. Power factor > .9. PoE compatible: Integrates with Power over Ethernet lighting systems via standard, low-voltage wires. PoE runs require an independent PoE node and power feed for each luminaire section.

Emergency Battery

Emergency output - 10 watts for 90 minutes.

Labels

UL and cUL listed. Suitable for Dry or Damp Locations, indoor use only.

Finish

Polyester powder coat applied over a multi-stage pre-treatment. The Naturals: 100% low VOC vinyl.

Lumen Maintenance

Reported: L70 at >61,000 hours Calculated: L70 at 470,000 hours
 L90 at >61,000 hours L90 at 115,000 hours

Derived from EPA TM-21 calculator. Based on typical conditions, consult factory for additional data.

Reliability

At Focal Point, our products are designed to stand the test of time. Each luminaire is engineered using superior components, manufactured with the utmost care and rigorously tested. Contact us for reliability data.

Warranty

LED system rated for operation in ambient environments up to 25°C. 5-year limited warranty.

PERFORMANCE CHARTS

See pages 3 & 4.

ORDERING

Luminaire Series

Seem 1 LED FSM1BW

FSM1BW

Shielding

Asymmetric Optic top/Asymmetric Lens bottom ASAS
 Asymmetric Optic top/Flush Lens bottom ASFL
 Asymmetric Optic top/0.5" Pop-Down Lens bottom ASPD05
 Dust Cover top/Asymmetric Lens bottom DCAS
 Dust Cover top/Flush Lens bottom DCFL
 Dust Cover top/Pop-Down Lens bottom DCPD05

Direct Distribution

125 Lumens per foot 125DN
(Consult factory for Lutron and DALI)
 250 Lumens per foot 250DN
 375 Lumens per foot 375DN
 500 Lumens per foot 500DN
 625 Lumens per foot 625DN

Indirect Distribution

125 Lumens per foot 125UP
(Consult factory for Lutron and DALI)
 250 Lumens per foot 250UP
 375 Lumens per foot 375UP
 500 Lumens per foot 500UP
 625 Lumens per foot 625UP
 800 Lumens per foot* 800UP
 1000 Lumens per foot* 1000UP
(*Not available with DALI)

Color Temperature

3000K, 80CRI or 90 CRI 30K or 930K
 3500K, 80CRI or 90 CRI 35K or 935K
 4000K, 80CRI or 90 CRI 40K or 940K

Circuits & Zones

1 Circuit, non-emergency 1C
 2 non-emergency circuits provide independent control of Direct and Indirect sources 2C
 Consult Ordering Guide on page 5 for multiple circuiting and zoning options _C_Z_DL

Voltage

120/277 UNV Volt UNV
 347 Volt 347
(LD1 driver only)
 Low Voltage LV

Control System & Dimming Level

0-10V - 10% Dimming LD1
 0-10V - 1% Dimming L11
 Low Voltage, PoE compatible LVN
(No driver. Not available with EM or EC. LV Voltage only.)
 Lutron Hi-Lume EcoSystem (LDE1) -
 1% Dimming LH1
 DALI 1% Dimming D11
(625 lumens per foot max)

Mounting

Wall Mount WM

WM

Factory Options

(See Ordering Guide on page 5 for ordering details for DC, EC, EM & ECD.)

Lit End Caps

LE
(Pair, adds 2" to overall luminaire length. ASFL & DCFL shielding only. Not available with P35K.)

Daylight Circuit

_DC

Emergency Circuit

_EC

Emergency Battery Pack†

_EM

Emergency Control Device†

_ECD
†(5' minimum length, 120/277 Volt only.)

Finish

(See finishes page for The Naturals options)

Black BK

Titanium Silver TS

Matte White Housing WH

Luminaire Length

Specify luminaire/row length in 1" increments _ft_in

ft in

(4' minimum. Leave blank for patterns. Smaller increments available, consult factory.)

Pattern Options

(4' minimum length)







'L' pattern A' x B'

'U' pattern A' x B' x C'

Rectangular pattern A' x B' R

(Consult factory for other pattern options)

4' PERFORMANCE CHART

					Lumens Per Watt (LPW)					
Direct Distribution	Indirect Distribution	Distribution % (Direct/Indirect)	Total Delivered Lumens	Tested System Watts						
					ASAS	ASFL	ASPD05	DCAS	DCFL	DCPD05
125DN	125UP	50/50	1000	12	87	84	84	87	84	84
	250UP	33/67	1500	16	103	100	101	101	98	99
	375UP	25/75	2000	19	111	109	109	109	107	107
	500UP	20/80	2500	22	118	116	117	116	114	114
	625UP	17/83	3000	26	122	120	121	120	118	118
	800UP	14/86	3700	33	122	120	121	119	118	118
	1000UP	11/89	4500	39	123	122	122	120	119	120
250DN	125UP	67/33	1500	16	101	96	97	101	97	97
	250UP	50/50	2000	19	111	108	108	110	106	107
	375UP	40/60	2500	23	116	113	114	115	112	112
	500UP	33/67	3000	26	122	119	120	120	117	118
	625UP	29/71	3500	30	125	122	123	123	120	121
	800UP	24/76	4200	36	124	122	122	122	120	120
	1000UP	20/80	5000	43	125	123	124	123	121	121
375DN	125UP	75/25	2000	20	105	101	101	106	101	102
	250UP	60/40	2500	24	113	109	110	112	108	109
	375UP	50/50	3000	27	117	114	114	116	112	113
	500UP	43/57	3500	30	122	119	119	120	117	118
	625UP	38/62	4000	34	124	122	122	123	120	120
	800UP	32/68	4700	41	124	122	122	122	120	120
	1000UP	25/75	5500	47	125	123	123	123	121	121
500DN	125UP	80/20	2500	25	109	103	104	110	103	104
	250UP	67/33	3000	28	116	110	110	115	109	109
	375UP	57/43	3500	32	119	114	114	118	112	113
	500UP	50/50	4000	35	123	118	119	121	117	117
	625UP	44/56	4500	39	125	121	121	123	119	120
	800UP	38/62	5200	45	124	121	121	123	119	119
	1000UP	33/67	6000	51	125	122	122	123	120	120
625DN	125UP	83/17	3000	30	107	101	99	107	101	99
	250UP	71/29	3500	33	112	107	105	112	106	104
	375UP	60/40	4000	37	116	111	109	114	110	108
	500UP	56/44	4500	40	119	115	113	118	114	112
	625UP	50/50	5000	44	121	117	116	120	116	115
	800UP	44/56	5700	50	121	118	117	120	116	115
	1000UP	35/65	6500	57	122	119	118	121	117	116

*Based on 3500K, 4' lengths. Lumen Multipliers: Preferred Light = 0.65, 90 CRI = 0.87, Delivered lumens may vary +/- 5%. Actual wattage may vary +/- 5%.

LIT END CAP PERFORMANCE CHART

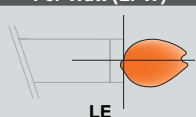
Direct Distribution	Delivered Lumens Per End Cap	Tested System Watts Per End Cap	Lumens Per Watt (LPW)
			
125LF	55	0.6	91
250LF	115	1.0	110
375LF	172	1.5	116
500LF	229	1.9	119
625LF	291	2.5	116

Based on 3500K. Lumen multipliers: 90 CRI = 0.87. Delivered lumens may vary +/- 5%. Actual wattage may vary +/- 5%. Tested System Watts is not incremental, but the portion of overall wattage consumed by the Lit End Cap module

ASYMMETRIC OPTIC / ASYMMETRIC LENS

Standard Application Example

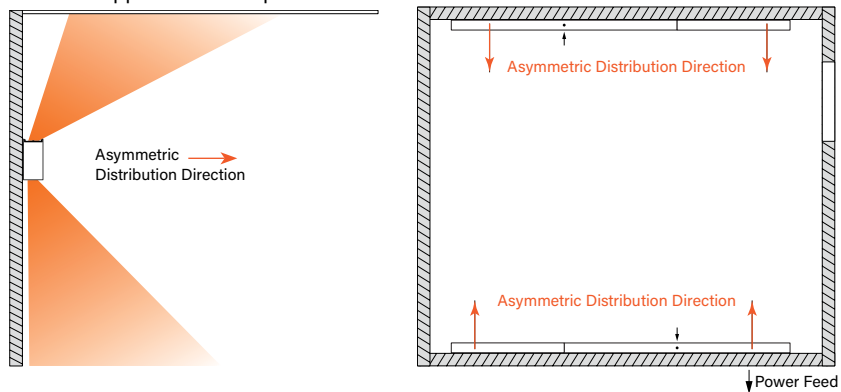

Finishes



STANDARD FINISHES



WHITE WH BLACK BK TITANIUM SILVER TS

THE NATURALS (25% SCALE)



LIGHT OAK LOK GRAY ELM GRE CHESTNUT CHT WALNUT WLT WOVEN LINEN WLN

Ordering Guide



Bidirectional Linear Circuitry, Zones & Factory Options

HOW TO USE THIS GUIDE

Fill out the worksheet on the following page to specify your requirements for circuitry, zones, and factory options.

Refer to the run chart for standard run configurations, consult factory for custom configurations.

Complete the Totals / Ordering Codes at the bottom of the worksheet and add to your ordering logic on the cut sheet.

Submit the worksheet along with your order.

TOTAL RUN LENGTH: <u>24ft</u>		JOB NAME: _____				FIXTURE TYPE: _____			
HOUSING SECTION	SECTION LENGTH	LIGHT DISTRIBUTION	SHARED ELECTRICAL FEED, NORMAL POWER			FACTORY OPTIONS			
			SWITCHING CIRCUIT	DIMMING ZONE	DAYLIGHT ZONE	SEPARATE ELECTRICAL FEEDS			EM
1	8	Indirect	1C	1Z					
		Direct					1EC		
2	8	Indirect	1C	1Z					
		Direct	2C	2Z					
3	8	Indirect	1C	1Z					
		Direct	2C		1DL				
Totals / Ordering Codes			2C	2Z	1DL		1EC		

ORDERING: FSM4BS-FL-625UP-125DN-35K- **2C2Z1DL** -UNV-LD1-C24- **1EC** -WH-24ft

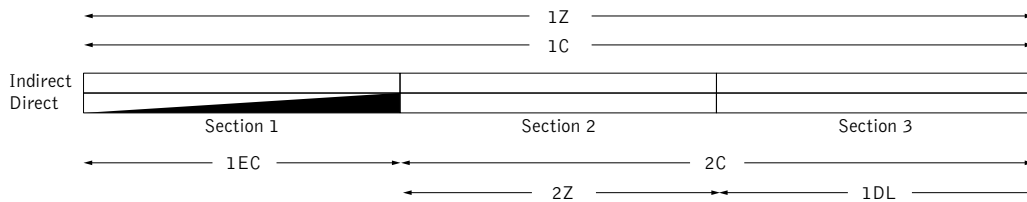

KEY	
C = Switching Circuit Switched Hot / Shared Neutral	DC = Daylight Circuit Switched Hot / Separate Neutral
Z = Dimming Zone Dimming Control Wires	EC = Emergency Circuit Switched Hot / Separate Neutral
DL = Daylight Zone Daylight Dimming Control Wires	ECD = Emergency Control Device Unswitched Hot / Separate Neutral
	EM = Emergency Battery Unswitched Hot / Shared Neutral

DEFAULTS

- Zones and Factory Options illuminate entire sections from 4' to 8' in length.
- EC, EM, and ECD only available for direct distribution.
- One shared or isolated circuit and zone required per housing section.
- Additional electrical feed required for applications greater than three shared circuits and zones.
- Limit of one EM or ECD per housing section.
- Each EC, DC and ECD require an additional electrical feed.
- ECD not available in the same housing section as EC.
- Longer lead times and additional pricing may apply for custom run configurations.

CUSTOM LENGTHS

- If partial illumination of emergency or daylight section is required, indicate in ordering guide and add "partial illumination" in Order Notes. Drawing required.
- Engineering validation required, longer lead times may apply.

Ordering Guide Worksheet

Linear Circuitry, Zones & Factory Options



FOCAL POINT®

TOTAL RUN LENGTH: _____		JOB NAME: _____				FIXTURE TYPE: _____			
HOUSING SECTION	SECTION LENGTH	LIGHT DISTRIBUTION	SHARED ELECTRICAL FEED, NORMAL POWER			FACTORY OPTIONS			EM
			SWITCHING CIRCUIT	DIMMING ZONE	DAYLIGHT ZONE	SEPARATE ELECTRICAL FEEDS			
						DAYLIGHT CIRCUIT	EMERGENCY CIRCUIT	ECD	
1		Indirect							
		Direct							
2		Indirect							
		Direct							
3		Indirect							
		Direct							
4		Indirect							
		Direct							
5		Indirect							
		Direct							
6		Indirect							
		Direct							
7		Indirect							
		Direct							
8		Indirect							
		Direct							
9		Indirect							
		Direct							
10		Indirect							
		Direct							
11		Indirect							
		Direct							
12		Indirect							
		Direct							
Totals / Ordering Codes									

WORKSHEET

Combine to create Circuits & Zones ordering code Enter as individual Factory Options

RUN CHART

Run length (ft)	Housing Configuration Section Lengths	Run length (ft)	Housing Configuration Section Lengths	Run length (ft)	Housing Configuration Section Lengths	Run length (ft)	Housing Configuration Section Lengths
9	5 + 4	21	8 + 8 + 5	33	8 + 8 + 8 + 5 + 4	45	8 + 8 + 8 + 8 + 8 + 5
10	6 + 4	22	8 + 8 + 6	34	8 + 8 + 8 + 6 + 4	46	8 + 8 + 8 + 8 + 8 + 6
11	7 + 4	23	8 + 8 + 7	35	8 + 8 + 8 + 7 + 4	47	8 + 8 + 8 + 8 + 8 + 7
12	8 + 4	24	8 + 8 + 8	36	8 + 8 + 8 + 8 + 4	48	8 + 8 + 8 + 8 + 8 + 8
13	8 + 5	25	8 + 8 + 5 + 4	37	8 + 8 + 8 + 8 + 5		
14	8 + 6	26	8 + 8 + 6 + 4	38	8 + 8 + 8 + 8 + 6		
15	8 + 7	27	8 + 8 + 7 + 4	39	8 + 8 + 8 + 8 + 7		
16	8 + 8	28	8 + 8 + 8 + 4	40	8 + 8 + 8 + 8 + 8		
17	8 + 5 + 4	29	8 + 8 + 8 + 5	41	8 + 8 + 8 + 8 + 5 + 4		
18	8 + 6 + 4	30	8 + 8 + 8 + 6	42	8 + 8 + 8 + 8 + 6 + 4		
19	8 + 7 + 4	31	8 + 8 + 8 + 7	43	8 + 8 + 8 + 8 + 7 + 4		
20	8 + 8 + 4	32	8 + 8 + 8 + 8	44	8 + 8 + 8 + 8 + 8 + 4		

Standard run configurations, consult factory for custom configurations.