

Seem® 4 Grid Ceiling LED

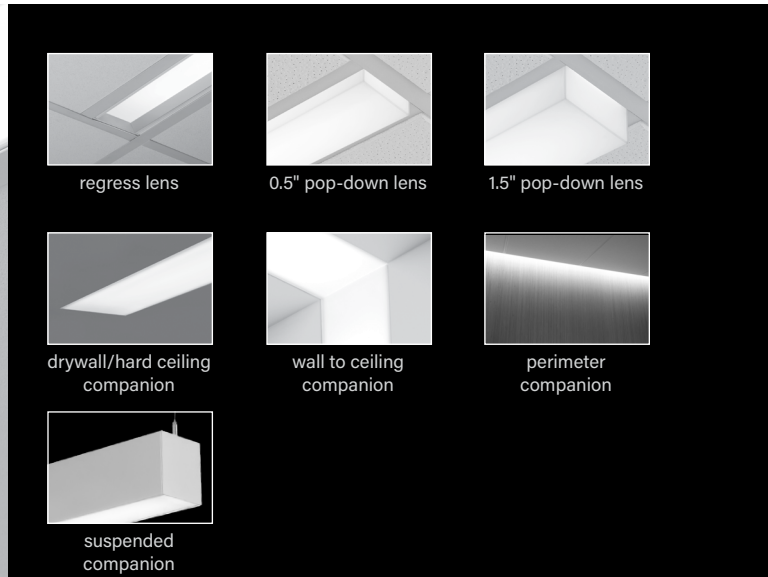

DIMENSIONAL DATA

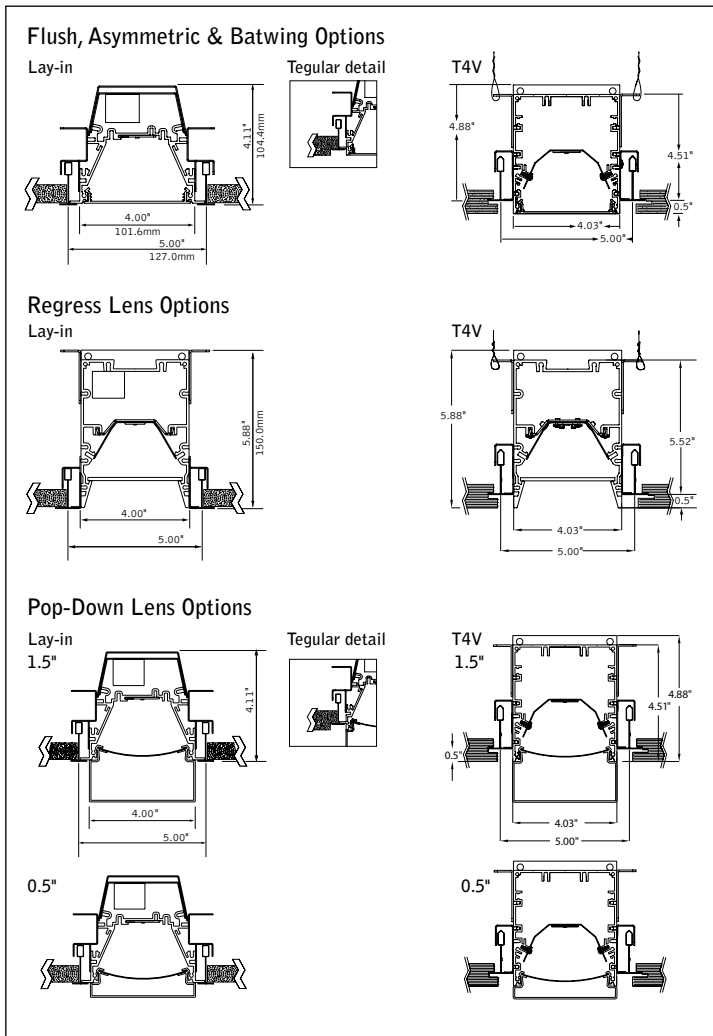

FEATURES

4" aperture recessed slot LED integrates with grid ceilings for a clean, unobtrusive aesthetic.

Individual units and continuous runs in 1" increments.

Available in flush, asymmetric, asymmetric room fill, batwing, regress, 0.5" or 1.5" pop-down lens.

LED position and lens material optimized to provide the perfect blend of high performance and visual comfort.

Tunable White: Supports human activity, well-being, and preferences with a light quality that evolves throughout the day.

Connected Solutions: Integrates with wired and wireless building lighting control systems.

PoE compatible: Integrates with Power over Ethernet lighting systems via standard, low-voltage wires.

DISTRIBUTIONS

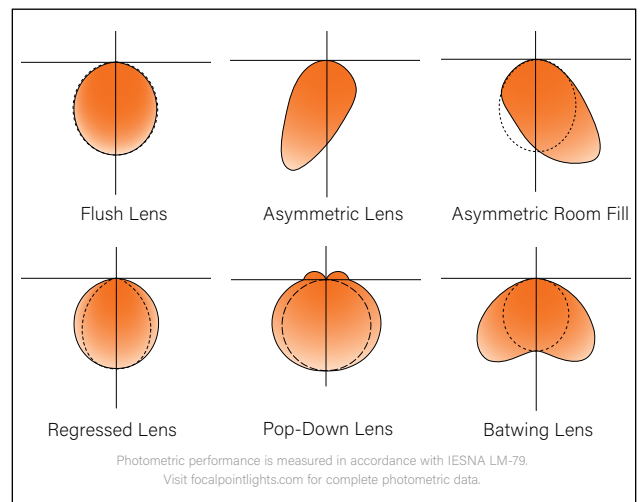

fixture:

project:

DETAILS

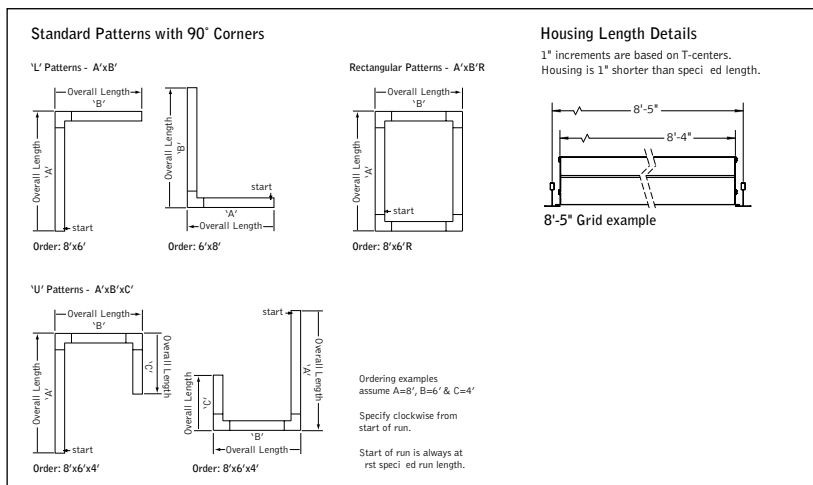

4' PERFORMANCE CHART

Lumen Output	Nominal Lumens	Tested System Watts	LPW			
			BW	FL	AS	AF
275LF	1100	10	120	142	122	124
375LF	1500	13	126	135	126	129
625LF	2500	22	125	122	126	128
875LF	3500	32	123	120	125	127
1000LF	4000	37	122	119	124	126
1125LF	4500	41	121	118	122	124
1250LF	5000	46	120	117	120	123

Based on 3500K, 80 CRI, 4' lengths. Lumen multiplier: 90+ CRI = 0.87. Lumen output may vary +/- 5%. Actual wattage may vary +/- 5%.

4' PERFORMANCE CHART - REGRESS

Lumen Output	Nominal Lumens	Tested System Watts	LPW	
			SR	SRXP
275LF	1100	12	79	98
375LF	1500	16	84	109
625LF	2500	26	84	110
875LF	3500	39	80	105
1000LF	4000	46	77	101
1125LF	4500	53	76	101
1250LF	5000	59	75	99

Based on 3500K, 80 CRI, 4' lengths. Lumen multiplier: 90+ CRI = 0.87. Lumen output may vary +/- 5%. Actual wattage may vary +/- 5%.

4' PERFORMANCE CHART - POP-DOWN

Lumen Output	Nominal Lumens	0.5"		1.5"	
		Tested System Watts	LPW	Tested System Watts	LPW
275LF	1100	13	89	12	89
375LF	1500	18	91	17	92
625LF	2500	32	88	30	88
750LF	3000	38	86	38	87

Based on 3500K, 80 CRI, 4' lengths. Lumen multiplier: 90+ CRI = 0.87. Lumen output may vary +/- 5%. Actual wattage may vary +/- 5%.

STANDARD WHITE

Luminaire Series

Seem 4 LED **FSM4L**

Shielding

- Asymmetric Lens **AS**
- Asymmetric Room Fill **AF**
- Batwing Lens **BW**
- Flush Satin Lens **FL**
- Regress Lens **SR**
- Regress High Performance Lens **SRXP**
- 0.5" Pop-Down Lens (750LF max.) **PD05**
- 1.5" Pop-Down Lens (750LF max. individual units only) **PD15**

Lumen Output

- 275 Lumens per foot (Not available with LHI.) **275LF**
- 375 Lumens per foot (Not available with LHI.) **375LF**
- 625 Lumens per foot **625LF**
- (BW, FL & SR 3' min. individual units only with LHI. SRXP 4' min. individual units only with LHI.)
- 750 Lumens per foot (Pop-Down Lenses only) **750LF**
- 875 Lumens per foot **875LF**
- (SR & SRXP 3' min. individual units only with LHI.)
- 1000 Lumens per foot **1000LF**
- 1125 Lumens per foot **1125LF**
- 1250 Lumens per foot **1250LF**

Color Temperature

- 2700K, 80+ CRI or 90+ CRI **27K or 927K**
- 3000K, 80+ CRI or 90+ CRI **30K or 930K**
- 3500K, 80+ CRI or 90+ CRI **35K or 935K**
- 4000K, 80+ CRI or 90+ CRI **40K or 940K**

Circuits & Zones

- 1 Circuit, non-emergency **1C**
- Consult Ordering Guide on page 6 for multiple circuiting and zoning options **_C_Z_DL**

Voltage

- 120/277 UNV Volt **UNV**
- Low Voltage **LV**

Control System & Dimming Level

- 0-10V - 10% Dimming **LD1**
- 0-10V - 1% Dimming **L11**
- Low Voltage, PoE compatible **LVN**
- (No driver. Not available with EM or EC. LV Voltage only.)
- Lutron Hi-Lume EcoSystem (LDE1) - 1% Dimming (625LF min.) **LH1**
- DALI 1% Dimming (1000LF max.) **D11**
- Wattstopper DLM - 1% Dimming** **DLM1**
- Wattstopper Fixture Sensor Low Density - 1% Dimming **LMFS1**
- Wattstopper Fixture Sensor High Density - 1% Dimming **LMFSD**
- Lutron Athena Wireless Node** **LAW1**
- Lutron Athena Wireless Sensor** **LAWS**
- Acuity nLight - 1% Dimming** **NLT1**
- Enlighted Smart Sensor - 1% Dimming** **ENL1**
- Encelium CLM Connected Lighting Module - 1% Dimming **CLM1**
- Current NX Enabled - 1% Dimming** **NXE1**
- WaveLinx Pro - 1% Dimming** **WLXP**

** (3' min. length. 7' min. length with ECD/EM. Not available with Pop-Down Lenses.) See sensor layout guide

Ceiling Configuration

- Std. 15/16" Lay-in or Std. 15/16" Tegular **G1 or T1**
- Std. 9/16" Lay-in or Std. 9/16" Tegular **G2 or T2**
- 9/16" Slot-tee Tegular **G3**
- Tall 15/16" Lay-in or Tall 15/16" Tegular **G4 or T4**
- Tall 15/16" Tegular for specialty ceilings (0.5" drop) **T4V**
- Tall 9/16" Lay-in or Tall 9/16" Tegular **G5 or T5**
- Node 9/16" Tegular **T6**

Factory Options

(See page 6 for ordering details for DC, EC, EM & ECD.)

- Chicago Plenum **CP**
- (Not available with Flex Whip, DLM1, NLT1 or NXE1.)
- Daylight Circuit **_DC**
- Emergency Circuit **_EC**
- Emergency Battery Pack† **_EM**
- Emergency Control Device† **_ECD**

† (4' minimum. 6' minimum with patterns. Not available at corners. 120/277 Volt only.)

- 6' New York City Flex Whip 120V or 277V **FNY1 or FNY2**
- 6' Flex Whip **FW**

Finish

- Matte White Housing **WH**

Luminaire Length

Specify luminaire/row length in 1" increments **_ft_in**

(2' minimum, lengths are nominal. 1" increments based on T-centers. Housing length is 1" shorter than specified. Leave blank for patterns. Smaller increments available, consult factory. Individual units cannot be joined in the field.)

Pattern Options

(4' min. length. Not available with Pop-Down Lenses. Consult factory for other pattern options.)

- 'L' pattern **A' x B'**
- 'U' pattern **A' x B' x C'**
- Rectangular pattern **A' x B' R**



Options in orange qualify for the Quickship program, 1000' total, 48' maximum per pattern section. Refer to Quickship Guide for complete details including EM/EC options.

fixture:

project:



TUNABLE WHITE

DETAILS

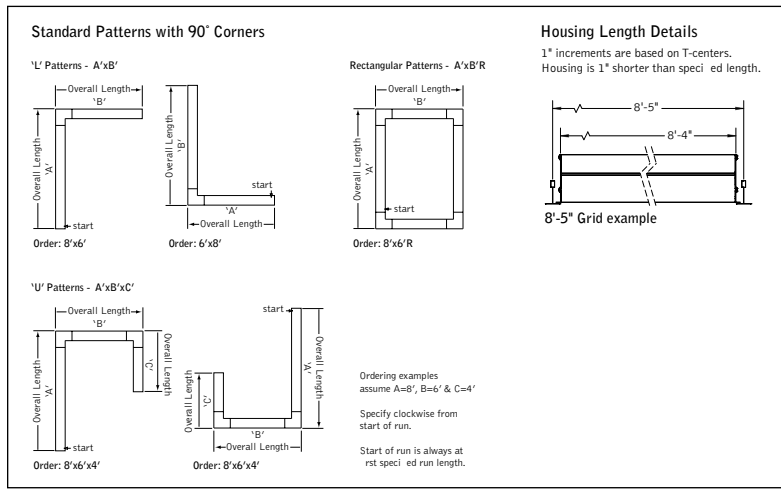

TW 4' PERFORMANCE CHART

Lumen Output	Nominal Lumens	Tested System Watts	LPW	
			BW	FL
275LF	1100	13.30	87.1	84.9
375LF	1500	17.34	90.6	88.3
625LF	2500	27.84	93.8	91.4
875LF	3500	37.22	98.7	96.2
1000LF	4000	42.39	98.9	96.4
1125LF	4500	50.27	93.7	91.3

Based on 2700K, 80CRI, 4' lengths. Lumen output may vary +/- 5%. Actual wattage may vary +/- 5%.

TW 4' PERFORMANCE CHART - REGRESS

Lumen Output	Nominal Lumens	Tested System Watts	LPW	
			SR	SRXP
275LF	1100	14.72	74.4	88.6
375LF	1500	19.36	77.5	92.3
625LF	2500	31.47	79.6	94.8
875LF	3500	42.01	83.4	99.4
1000LF	4000	50.68	79.2	94.3

Based on 2700K, 80CRI, 4' lengths. Lumen output may vary +/- 5%. Actual wattage may vary +/- 5%.

TW 4' PERFORMANCE CHART - POP-DOWN

Lumen Output	Nominal Lumens	0.5"		1.5"	
		Tested System Watts	LPW	Tested System Watts	LPW
275LF	1100	17.14	59.7	16.33	65.7
375LF	1500	22.79	61.4	21.58	68.3
625LF	2500	35.49	65.2	33.96	72.0
750LF	3000	42.39	65.4	40.28	72.7

Based on 2700K, 80CRI, 4' lengths. Lumen output may vary +/- 5%. Actual wattage may vary +/- 5%.

Lumen Multipliers

CRI	Multiplier
80+	1.00
90+	0.89

Wattage Multipliers

CCT	Multiplier
2700K	1.00
3000K	0.92
3500K	0.88
4000K	0.86
5000K	0.85
5700K	0.87
6500K	0.90

Focal Point LLC reserves the right to change specifications for product improvement without notification.

Luminaire Series

Seem 4 LED FSM4L

Shielding

Batwing Lens BW

Flush Satin Lens FL

Regress Lens (1000LF max.) SR

Regress High Performance Lens (1000LF max.) SRXP

0.5" Pop-Down Lens (750LF max.) PD05

1.5" Pop-Down Lens (750LF max. individual units only) PD15

Lumen Output

275 Lumens per foot (BW, FL, SR & SRXP 3' min. with DTTW) 275LF

375 Lumens per foot (BW, FL, SR & SRXP 3' min.) 375LF

625 Lumens per foot 625LF

750 Lumens per foot (Pop-Down Lenses only) 750LF

875 Lumens per foot 875LF

1000 Lumens per foot 1000LF

1125 Lumens per foot 1125LF

Color Temperature

Tunable White: 2700-6500K, 80+ CRI 2765T

Tunable White: 2700-6500K, 90+ CRI 92765T

Circuits & Zones

1 Circuit, non-emergency 1C

Consult Ordering Guide on page 6 for multiple circuiting and zoning options

Voltage

120/277 UNV Volt UNV

Control System & Dimming Level

DALI 1% Dimming D1TW

(Default driver offers DT6 control. It requires two addresses, one for intensity & one for CCT tuning. Consult factory for DT8. Extended lead time applies.)

Lutron Athena Wireless Sensor** LAWS

Acuity nLight - 1% Dimming** NLT1

Enlighted Smart Sensor - 1% Dimming** ENL1

** (Consult factory. Not available with Pop-Down Lenses.)

See sensor layout guide

Ceiling Configuration

Std. 15/16" Lay-in or Std. 15/16" Tegular G1 or T1

Std. 9/16" Lay-in or Std. 9/16" Tegular G2 or T2

9/16" Slot-tee Tegular G3

Tall 15/16" Lay-in or Tall 15/16" Tegular G4 or T4

Tall 15/16" Tegular for specialty ceilings (0.5" drop) T4V

Tall 9/16" Lay-in or Tall 9/16" Tegular G5 or T5

Node 9/16" Tegular T6

Factory Options

(See page 6 for ordering details for DC, EC, EM & ECD.)

Chicago Plenum

(Not available with Flex Whip, NLT1 or NXE1.)

Daylight Circuit

_DC

Emergency Circuit

_EC

Emergency Battery Pack¹

_EM

Emergency Control Device[†]

_ECD

[†](Consult factory)

6' New York City Flex Whip 120V or 277V FNY1 or FNY2

6' Flex Whip FW

Finish

Matte White Housing WH

Luminaire Length

Specify luminaire/row length in 1" increments _ft _in

(2" minimum, lengths are nominal. 1" increments based on T-centers. Housing length is 1" shorter than specified. Leave blank for patterns. Smaller increments available, consult factory. Individual units cannot be joined in the field.)

Pattern Options

(4' min. length. Not available with Pop-Down Lenses. Consult factory for other pattern options.)

'L' pattern A' x B'

'U' pattern A' x B' x C'

Rectangular pattern A' x B' R

FSM4L

UNV

WH

ft in

SPECIFICATIONS

LED System

Proprietary linear LED module incorporates premium LEDs on a robust platform to achieve excellent thermal management. LEDs are placed to promote a uniform appearance. Available in 2700K, 3000K, 3500K or 4000K with CRI>80 or CRI>90, 3 SDCM or Tunable White (2700K-6500K), CRI>80, >90. 3500K and 4000K with CRI>90 have a cyanosis observation index (COI) of 3.3 or less. LED modules are replaceable from below. Asymmetric, Flush, Batwing and Pop-Down lenses driver access from above. Regress lens driver access from below.

Construction

One piece extruded aluminum housing, 20 Ga. steel end caps. Steel driver compartment, flush lens only. Flush, Batwing and Pop-Down lens weights: 4' unit: 11 lbs., 8' unit: 22 lbs. Regress lens weights: 4' unit: 20 lbs., 8' unit: 40 lbs.

Optic

Asymmetric, Flush, Batwing lens extruded acrylic .085" thick with satin finish up to 8' continuous. Pop-Down lens extruded acrylic .06" thick with frosted finish, up to 8' continuous. Regress lens .118" thick acrylic lay-in lens. 22 Ga. reflector finished in High Reflectance White powder coat.

Electrical

Luminaires are pre-wired with factory installed branch circuit wiring and over-molded quick connects. Standard 120-277V constant current driver includes 0-10V analog dimming. Power factor >.9. PoE compatible: Integrates with Power over Ethernet lighting systems via standard, low-voltage wires. PoE runs require an independent PoE node and power feed for each luminaire section.

Emergency

Emergency Battery output - 10 watts for 90 minutes. Maximum mounting height: 19.2ft. Emergency Circuit with Connected Solutions (DLM1, LMFS1, LMFSD, NLT1, ENL1, CLM1, NXE1, WLXP) shipped standard with leads to connect UL924 compliant device, by others.

Labels

UL and cUL listed. Suitable for Dry or Damp Locations, indoor use only.

Finish

Polyester powder coat applied over a multi-stage pre-treatment.

Lumen Maintenance

Reported: L70 > 61,000 hours
L90 > 61,000 hours

Calculated: L70 at > 480,000 hours
L90 at > 128,000 hours

Derived from EPA TM-21 calculator. Based on typical conditions, consult factory for additional data.

Reliability

At Focal Point, our products are designed to stand the test of time. Each luminaire is engineered using superior components, manufactured with the utmost care and rigorously tested. Contact us for reliability data.

Warranty

LED system rated for operation in ambient environments up to 25°C. 5-year limited warranty.



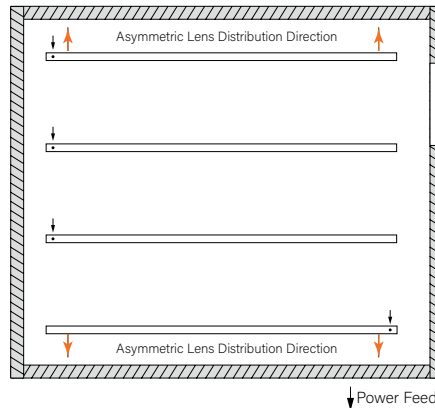
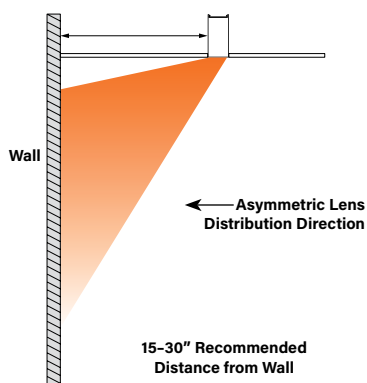



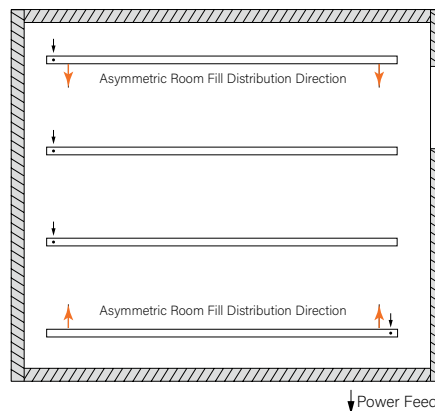
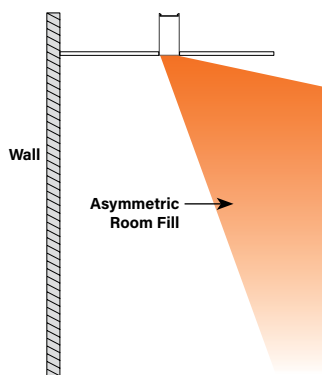



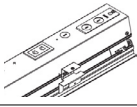

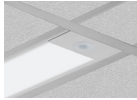



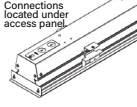



DIRECT ASYMMETRIC Standard Application Example

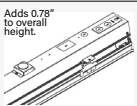

DIRECT ASYMMETRIC ROOM FILL Standard Application Example

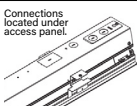

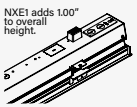
Focal Point provides flexibility in meeting the needs of each project by integrating with several building lighting control systems. A variety of sensors, drivers and other components can be specified that allow the luminaires to communicate with wired and wireless networks. All zoning can be digitally reconfigured through the application software. Daylight harvesting, occupancy sensing, integration with HVAC systems, and individual controls enable the monitoring and modulating of light levels and temperature in order to save energy, reduce costs and maximize occupants' comfort. All Connected Solutions luminaires require a compatible building control system.†

Connected Solution	Ordering Code	Model #**	Protocol	Compatible Networks*	Occupancy & Daylight	Temperature Reporting	Communication to Luminaire	Drivers	
 legrand WATTSTOPPER®		DLM1	LMFC-011	DLM	DLM	Enabled	No	Wired 	Advance by Signify , Optotronic by eldoLED
		LMFS1	LMFS-601 & LMFI-111	DLM Wireless	DLM	Enabled	No	Wireless	Advance by Signify
		LMFSD	LMFS-601						Optotronic by eldoLED (Dexal)
 COOPER Lighting Solutions		WLXP	OEM-WAA	WaveLinX Wireless	WaveLinX Pro Trellix	Enabled	No	Wireless (WaveLinX Pro Wireless Area Controller)	Advance by Signify
 CRESTRON		D11	Specified Driver	DALI	Crestron Züm Wireless & SpaceBuilder	Enabled	No	Wired	eldoLED ECOdrive
		L11		0-10V					Advance by Signify
 ENCELIUM		CLM1	ZBHA-CLM-DIM-ENC	ZigBee	Encelium X Light Management System	Enabled	No	Wireless	Optotronic by eldoLED Advance by Signify
 Enlighted		ENL1	SU-5E-IOT	Enlighted RF	Enlighted	Integrated	Yes	Wireless	Advance by Signify
 LUTRON		LAW1	A-WN-D01-RF-WH	DALI, 0-10V	Athena Wireless	Enabled	No	Wireless	Advance by Signify
		LAWS	A-WN-D01-OCC-WH	DALI, 0-10V	Athena Wireless	Integrated	No	Wireless	Advance by Signify
		LH1	LDE1	EcoSystem	Quantum, Energi Savr Node, Energi TriPak	Enabled	No	Wired	Lutron Hi-Lume
 nLIGHT		NLT1	nEPS-60-IO	nLight	nLight	Enabled	No	Wired 	eldoLED ECOdrive , eldoLED SOLOdrive
 NA LIGHTING CONTROLS		NXE1	NXFM-LV	NX	NX Distributed Intelligence	Enabled	No	Wired 	Optotronic by eldoLED

*Not all compatible networks may be listed. **For performance data and additional control system details please visit the connected solutions manufacturer websites. Primary drivers are listed in bold. To specify a particular driver please consult factory. †Controls systems supplied by others.