

Seem® 2

LED

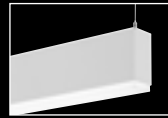

0.5" pop-down lens

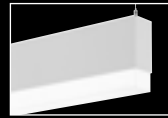

1.5" pop-down lens

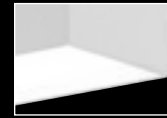

end detail

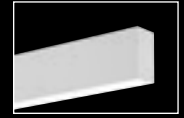

wall mount companion



The Naturals collection - Gray Elm shown



recessed companion



wall to ceiling companion

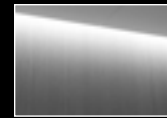

perimeter companion



direct/indirect companion

DIMENSIONAL DATA

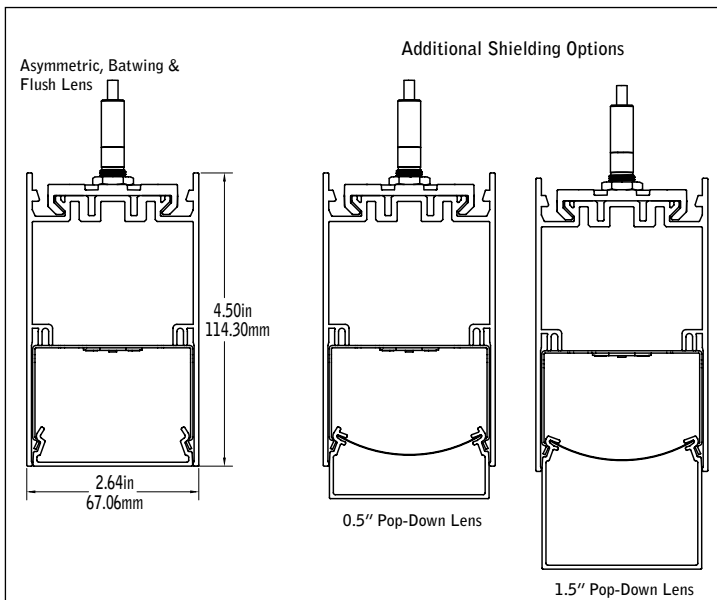

MOUNTING INFORMATION

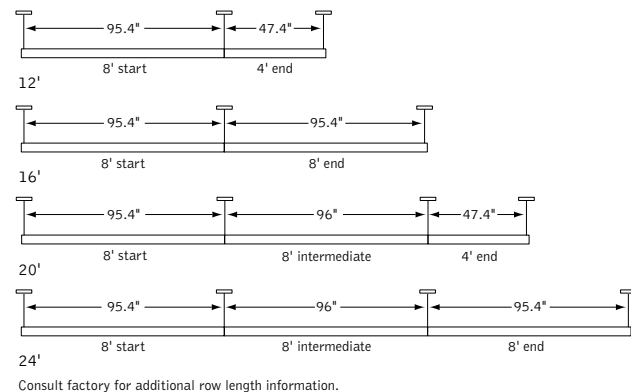

FEATURES

Narrow 2.5" linear direct LED with Asymmetric, Batwing, Flush, 0.5" or 1.5" Pop-Down lens.

Frosted acrylic lens provides uninterrupted illumination, without pixels or shadows.

Individual units and continuous runs in 1' increments.

Connected Solutions: Integrates with wired and wireless building lighting control systems.

PoE compatible: Integrates with Power over Ethernet lighting systems via standard, low-voltage wires.

Available with The Naturals, a series of finishes that exude biophilic beauty.

DISTRIBUTIONS

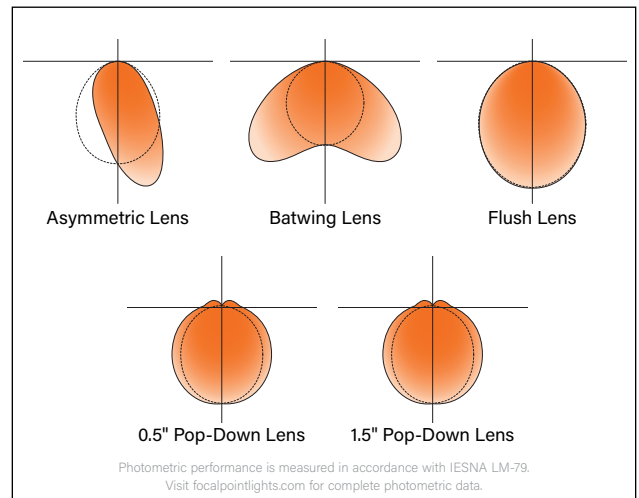

MOUNTING INFORMATION

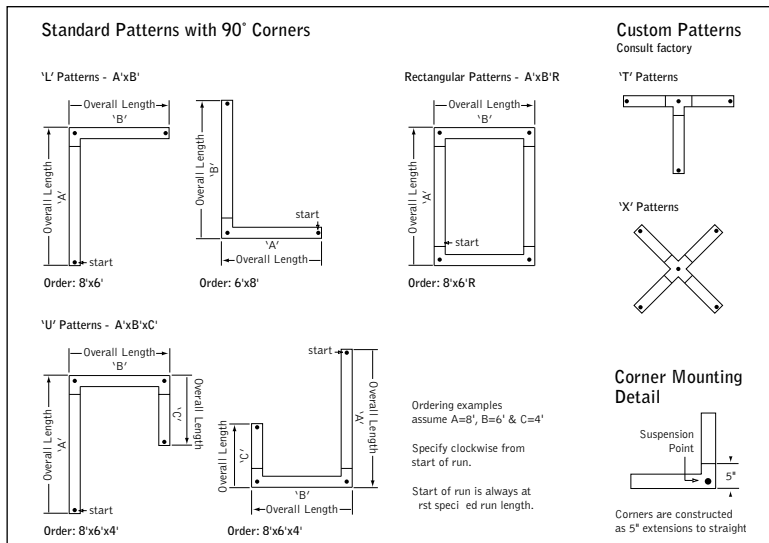

SPECIFICATIONS

LED System

Proprietary linear LED module incorporates premium LEDs on a robust platform to achieve excellent thermal management. LEDs are placed to promote a uniform appearance. Available in 2700K, 3000K, 3500K or 4000K with CRI>80 or CRI>90, 3 SDCM. 3500K and 4000K with CRI>90 have a cyanosis observation index (COI) of 3.3 or less. LED modules and drivers are replaceable from below.

Construction

One piece extruded aluminum housing. Cast aluminum end caps. 8' unit weight: 30 lbs.

Optic

Reflectors fabricated of 22 Ga. steel finished in matte white powder coat. Extruded acrylic lens with satin finish, up to 8' continuous.

Electrical

Luminaires are pre-wired with factory installed branch circuit wiring and over-molded quick connects. Standard 120-277V constant current driver includes 0-10V analog dimming. Power factor > .9. PoE compatible: Integrates with Power over Ethernet lighting systems via standard, low-voltage wires. PoE runs require an independent PoE node and power feed for each luminaire section.

Emergency

Emergency Battery output - 10 watts for 90 minutes. Maximum mounting height: 20 ft. Emergency Circuit with Connected Solutions (DLM1, LMFS1, LMFSD, NLT1, ENL1, CLM1, NXE1, WLXP) shipped standard with leads to connect UL924 compliant device, by others.

Labels

UL and cUL listed. Suitable for Dry or Damp Locations, indoor use only.

Finish

Polyester powder coat applied over a multi-stage pre-treatment. Canopy and cord white as standard. The Naturals: 100% low VOC vinyl.

Lumen Maintenance

Reported: L70 at >61,000 hours Calculated: L70 at 385,000 hours
 L90 at >61,000 hours L90 at 103,000 hours

Derived from EPA TM-21 calculator. Based on typical conditions, consult factory for additional data.

Reliability

At Focal Point, our products are designed to stand the test of time. Each luminaire is engineered using superior components, manufactured with the utmost care and rigorously tested. Contact us for reliability data.

Warranty

LED system rated for operation in ambient environments up to 25°C. 5-year limited warranty.

4' PERFORMANCE CHART

See page 3.

ORDERING

Luminaire Series

Seem 2 LED **FSM2LS**

Shielding

Asymmetric Lens **AS**
 Batwing Lens **BW**
 Flush Satin Lens **FL**
 0.5" Pop-Down Lens **PD05**
 1.5" Pop-Down Lens **PD15**
 (Individual units only)

Lumen Output

125 Lumens per foot **125LF**
 (LD1 & L11 only, 4' minimum.)
 250 Lumens per foot **250LF**
 (3' minimum with LHL)
 375 Lumens per foot **375LF**
 500 Lumens per foot **500LF**
 625 Lumens per foot **625LF**
 750 Lumens per foot **750LF**
 875 Lumens per foot **875LF**
 1000 Lumens per foot **1000LF**

Color Temperature

2700K, 80+ CRI or 90+ CRI **27K or 927K**
 3000K, 80+ CRI or 90+ CRI **30K or 930K**
 3500K, 80+ CRI or 90+ CRI **35K or 935K**
 4000K, 80+ CRI or 90+ CRI **40K or 940K**

Circuits & Zones

1 Circuit, non-emergency **1C**
 Consult Ordering Guide on page 5 for multiple **_C_Z_DL**
 circuiting and zoning options

Voltage

120/277 UNV Volt **UNV**
 347V **347**
 (LD1 & L11 only)
 Low voltage **LV**

Control System & Dimming Level

0-10V - 10% Dimming **LD1**
 0-10V - 1% Dimming **L11**
 Low Voltage, PoE compatible **LVN**
 (No driver. Not available with EM or EC. LV Voltage only.)
 Lutron Hi-Lume EcoSystem (LDE1) - 1% Dimming **LH1**
 DALI 1% Dimming **D11**
 (For 750LF, 875LF & 1000LF consult factory.)
 Wattstopper DLM - 1% Dimming** **DLM1**
 Wattstopper Fixture Sensor** **LMFS1**
 Low Density - 1% Dimming
 See sensor layout guide
 Wattstopper Fixture Sensor** **LMFSD**
 High Density - 1% Dimming
 See sensor layout guide
 Acuity nLight - 1% Dimming** **NLT1**
 Enlighted Smart Sensor - 1% Dimming** **ENL1**
 See sensor layout guide
 Encielum CLM Connected Lighting Module** **CLM1**
 1% Dimming
 Current NX Enabled - 1% Dimming** **NXE1**
 WaveLinX Pro - 1% Dimming** **WLXP**
 See sensor layout guide

** (3' minimum length, with ECD/EM - 7' minimum.)
 1 (Not available with pop-down lenses.)

Mounting

24" Cable Suspension **C24**
 48" Cable Suspension **C48**
 96" Cable Suspension **C96**

(Specify canopy color, see finishes page for options.)

Example: White = C24WH1

(Specify one of the following in place of "C")

J - for 2" canopies at non-feed locations. CS - for sloped ceiling applications.)

Surface Mount

SM
 (Not available with CLM1, DLM1, NLT1 or NXE1)

Factory Options

(See Ordering Guide on page 5 for ordering details for DC, EC, EM & ECD.)

Black Cord

BKCD

Daylight Circuit

_DC

Emergency Circuit

_EC

Emergency Battery Pack†

_EM

Emergency Control Device†

_ECD
 † (4' minimum, 120/277 Volt only.)

Finish

(See finishes page for The Naturals options)

Black

BK

Titanium Silver

TS

Matte White Housing

WH

Luminaire Length

Specify luminaire/row length in 1' increments **X'**

(2' minimum. Leave blank for patterns. Smaller increments available, consult factory.)

Pattern Options

(2' minimum length)

'L' pattern

A' x B'

'U' pattern

A' x B' x C'





Rectangular pattern

A' x B' R
 (Consult factory for other pattern options)



Options in orange qualify for the Quickship program. 1000' total. Refer to Quickship Guide for complete details including EM/EC options.

4' PERFORMANCE CHART

Lumen Output	Delivered Lumens	Tested System Watts	Lumens Per Watt (LPW)				
			 AS	 BW	 FL	 PD05	 PD15
125LF	500	6	95	91	88	81	82
250LF	1000	10	113	108	103	94	98
375LF	1500	14	120	116	105	101	100
500LF	2000	19	123	118	107	103	102
625LF	2500	24	121	116	105	101	101
750LF	3000	28	122	117	108	101	100
875LF	3500	34	120	115	104	100	100
1000LF	4000	39	119	114	105	101	100

Based on 3500K, 4' length. Lumen multipliers:
 Delivered lumens may vary +/- 5%. Actual wattage may vary +/- 5%

Focal Point provides flexibility in meeting the needs of each project by integrating with several building lighting control systems. A variety of sensors, drivers and other components can be specified that allow the luminaires to communicate with wired and wireless networks. All zoning can be digitally reconfigured through the application software. Daylight harvesting, occupancy sensing, integration with HVAC systems, and individual controls enable the monitoring and modulating of light levels and temperature in order to save energy, reduce costs and maximize occupants' comfort. All Connected Solutions luminaires require a compatible building control system.†

Connected Solution	Ordering Code	Model #**	Protocol	Compatible Networks*	Occupancy & Daylight	Temperature Reporting	Communication to Luminaire	Drivers
 WATTSTOPPER [®]	DLM1	LMFC-011	DLM	DLM	Enabled	No	Wired 	Advance by Signify. Optotronic by eldoLED
	LMFS1	LMFS-601 & LMFI-111	DLM Wireless	DLM	Enabled	No	Wireless	Advance by Signify
LMFSD	LMFS-601	Optotronic by eldoLED (Dexal)						
	WLXP	OEM-WAA	WaveLinx Wireless	WaveLinx Pro Trellix	Enabled	No	Wireless (WaveLinx Pro Wireless Area Controller)	Advance by Signify
	D11	Specified Driver	DALI	Crestron Züm Wireless & SpaceBuilder	Enabled	No	Wired	eldoLED ECOdrive
	L11		0-10V					Advance by Signify
	CLM1	ZBHA-CLM-DIM-ENC	ZigBee	Encelium X Light Management System	Enabled	No	Wireless	Optotronic by eldoLED Advance by Signify
	ENL1	SU-5E-IOT	Enlighted RF	Enlighted	Integrated	Yes	Wireless	Advance by Signify
	LH1	LDE1	EcoSystem	Quantum, Energi Savr Node, Energi TriPak	Enabled	No	Wired	Lutron Hi-Lume
 Connections located under access panel.	NLT1	nEPS-60-IO	nLight	nLight	Enabled	No	Wired 	eldoLED ECOdrive, eldoLED SOLOdrive
							Wireless	
	NXE1	NXFM-LV	NX	NX Distributed Intelligence	Enabled	No	Wired 	Optotronic by eldoLED

*Not all compatible networks may be listed. **For performance data and additional control system details please visit the connected solutions manufacturer websites. Primary drivers are listed in **bold**. To specify a particular driver please consult factory. †Controls systems supplied by others.

Finishes



STANDARD FINISHES



WHITE WH BLACK BK TITANIUM SILVER TS

THE NATURALS (25% SCALE)



LIGHT OAK LOK GRAY ELM GRE CHESTNUT CHT WALNUT WLT WOVEN LINEN WLN

Ordering Guide



Direct Only Linear Circuitry, Zones & Factory Options

HOW TO USE THIS GUIDE

Fill out the worksheet on the following page to specify your requirements for circuitry, zones, and factory options.

Refer to the run chart for standard run configurations, consult factory for custom configurations.

Complete the Totals / Ordering Codes at the bottom of the worksheet and add to your ordering logic on the cut sheet.

Submit the worksheet along with your order.

TOTAL RUN LENGTH: <u>32ft</u>		JOB NAME: _____			FIXTURE TYPE: _____				
EXAMPLE	HOUSING SECTION	SECTION LENGTH	SHARED ELECTRICAL FEED, NORMAL POWER			FACTORY OPTIONS			
			SWITCHING CIRCUIT	DIMMING ZONE	DAYLIGHT ZONE	SEPARATE ELECTRICAL FEEDS			EM
						DAYLIGHT CIRCUIT	EMERGENCY CIRCUIT	ECD	
1	8	1C	1Z					1EM	
2	8	2C	2Z						
3	8	2C	2Z						
4	8				1DC				
Totals / Ordering Codes		2C	2Z		1DC			1EM	

ORDERING: FSM4L-FL-625LF-35K- **2C2Z** -UNV-LD1-G2- **1DC-1EM** -WH-32ft

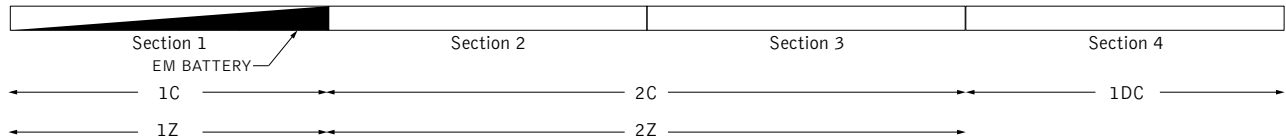

KEY	
C = Switching Circuit Switched Hot / Shared Neutral	DC = Daylight Circuit Switched Hot / Separate Neutral
Z = Dimming Zone Dimming Control Wires	EC = Emergency Circuit Switched Hot / Separate Neutral
DL = Daylight Zone Daylight Dimming Control Wires	EM = Emergency Battery Unswitched Hot / Shared Neutral
	ECD = Emergency Control Device Unswitched Hot / Separate Neutral

DEFAULTS

- Zones and Factory Options illuminate entire sections from 4' to 8' in length.
- One shared or isolated circuit and zone required per housing section.
- Limit of one EM or ECD per housing section.
- Additional electrical feed required for applications greater than three shared circuits and zones.
- Each DC, EC and ECD require an additional electrical feed.
- ECD not available in the same housing section as EC.
- Longer lead times and additional pricing may apply for custom run configurations.

CUSTOM LENGTHS

- If partial illumination of emergency or daylight section is required, indicate in ordering guide and add "partial illumination" in Order Notes. Drawing required.
- Engineering validation required, longer lead times may apply.

Ordering Guide Worksheet

Linear Circuitry, Zones & Factory Options



FOCAL POINT®

TOTAL RUN LENGTH: _____		JOB NAME: _____			FIXTURE TYPE: _____			
HOUSING SECTION	SECTION LENGTH	SHARED ELECTRICAL FEED, NORMAL POWER			FACTORY OPTIONS			EM
		SWITCHING CIRCUIT	DIMMING ZONE	DAYLIGHT ZONE	SEPARATE ELECTRICAL FEEDS			
DAYLIGHT CIRCUIT	EMERGENCY CIRCUIT				ECD			
1								
2								
3								
4								
5								
6								
7								
8								
9								
10								
11								
12								
13								
14								
15								
16								
17								
18								
19								
20								
Totals / Ordering Codes								

WORKSHEET

Combine to create Circuits & Zones ordering code

Enter as individual Factory Options

RUN CHART

Run length (ft)	Housing Configuration Section Lengths	Run length (ft)	Housing Configuration Section Lengths	Run length (ft)	Housing Configuration Section Lengths	Run length (ft)	Housing Configuration Section Lengths
9	5 + 4	21	8 + 8 + 5	33	8 + 8 + 8 + 5 + 4	45	8 + 8 + 8 + 8 + 8 + 5
10	6 + 4	22	8 + 8 + 6	34	8 + 8 + 8 + 6 + 4	46	8 + 8 + 8 + 8 + 8 + 6
11	7 + 4	23	8 + 8 + 7	35	8 + 8 + 8 + 7 + 4	47	8 + 8 + 8 + 8 + 8 + 7
12	8 + 4	24	8 + 8 + 8	36	8 + 8 + 8 + 8 + 4	48	8 + 8 + 8 + 8 + 8 + 8
13	8 + 5	25	8 + 8 + 5 + 4	37	8 + 8 + 8 + 8 + 5		
14	8 + 6	26	8 + 8 + 6 + 4	38	8 + 8 + 8 + 8 + 6		
15	8 + 7	27	8 + 8 + 7 + 4	39	8 + 8 + 8 + 8 + 7		
16	8 + 8	28	8 + 8 + 8 + 4	40	8 + 8 + 8 + 8 + 8		
17	8 + 5 + 4	29	8 + 8 + 8 + 5	41	8 + 8 + 8 + 8 + 5 + 4		
18	8 + 6 + 4	30	8 + 8 + 8 + 6	42	8 + 8 + 8 + 8 + 6 + 4		
19	8 + 7 + 4	31	8 + 8 + 8 + 7	43	8 + 8 + 8 + 8 + 7 + 4		
20	8 + 8 + 4	32	8 + 8 + 8 + 8	44	8 + 8 + 8 + 8 + 8 + 4		

Standard run configurations, consult factory for custom configurations.