

Nivo™ Acoustic

UNLIT CEILING TILE

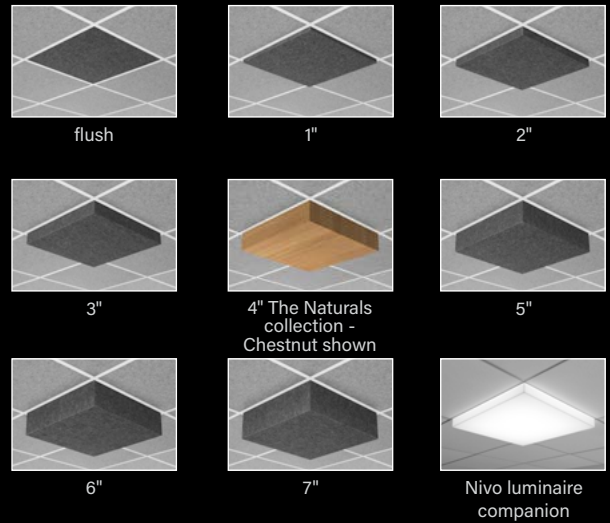

FOCAL POINT®

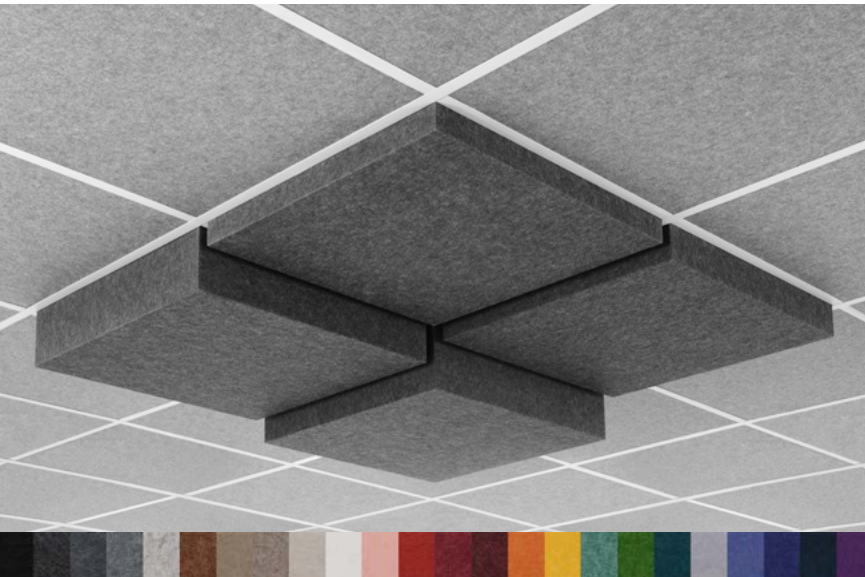

DIMENSIONAL DATA

4" Drop Tile

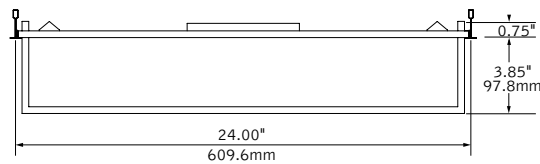

4" Drop Tile

Plenum/Chicago Plenum

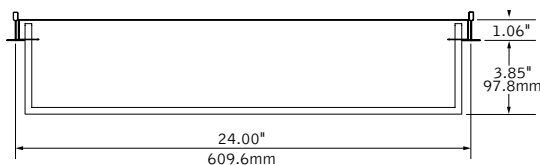

Tile options

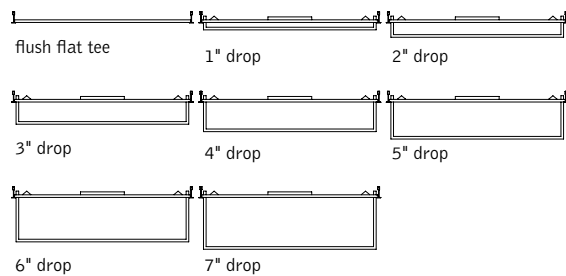

FEATURES

A 2x2 sound absorbing tile available in flush to 7" drop heights in 1" increments.

Pair with Nivo luminaires to create a coordinated look in interior spaces.

Noise Reduction Coefficient (NRC) ranges from 0.9 to 1.3 depending on tile drop height. Refer to ASTM C423 test reports for more information.

Wide range of color options provides design flexibility and personalization for any project.

Plenum option meets construction requirements for CCEA (Chicago Plenum) marking, 2015 IBC 602.2 & 2018 NFPA 90A.

Available with The Naturals, a series of finishes that exude biophilic beauty.

ACOUSTIC PERFORMANCE*

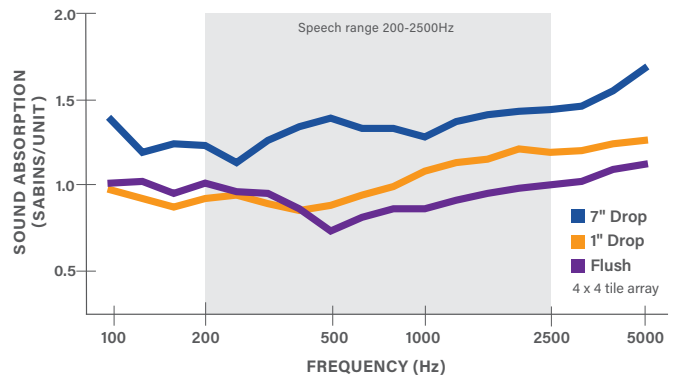

*Standard tile only. Plenum results will vary.

fixture:

project:

INSTALLATION REQUIREMENTS

Drop height (in)	Above ceiling clearance required (in)
Flush	7"
1"	10"
2"	12"
3"	14"
4"	17"
5"	19"
6"	21"
7"	23"

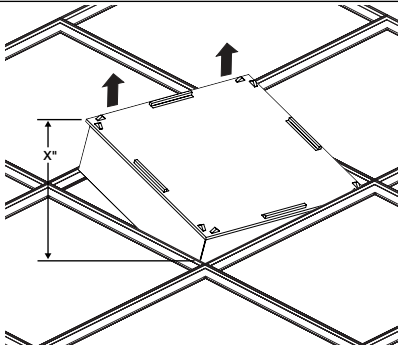

SPECIFICATIONS

Acoustic Material

Content	Housing material is 100% polyester containing up to 50% of recycled plastic bottles (PET felt) with an ASTM E-84 Class A / CAN ULC S102 fire rating and is moisture resistant. See page 3 for color offering. Acoustic material colors are subject to change without notice. For the most current color options, please visit www.focalpointlights.com/acousticsolutions . Lead times may vary depending on color.
Cleaning and Care	Remove dust and debris with a clean, soft, lint-free cloth or vacuum
PET Thickness	9mm

Acoustic Performance

Acoustic testing is performed on all Focal Point acoustic products and varies based on installation and configuration. ASTM C423 test reports can be downloaded from focalpointlights.com. Contact acoustic.solutions@focalpointlights.com for technical questions.

NRC	Noise Reduction Coefficient (NRC) is the average of how absorptive a material is at various frequencies within the human speech frequency range. Two materials with the same rating may not perform the same in application. Typically, an NRC of 0 indicates perfect reflection, and an NRC of 1 is designated as perfect absorption. However, based on the testing methodology and depending upon the material's shape or surface area products can test at an NRC greater than 1. NRC = 0.9 -1.3, dependent on tile drop height
------------	---

Weight

Individual tiles will not exceed 5lbs. Plenum/Chicago Plenum tiles will not exceed 8lbs.

Assembly & Installation

Field assembly required. Simple four-step installation process. Refer to installation instructions for details. Consult factory for pre-assembled options.

Reliability

At Focal Point, our products are designed to stand the test of time. Each product is engineered using superior components, manufactured with the utmost care and rigorously tested.

Warranty

1-year limited warranty.

ORDERING

Series	AUNV	AUNV
Nivo Acoustic	AUNV	
Nominal Size	22	22
2' x 2'	22	
<small>(consult factory for custom sizes)</small>		
Profile		
Flush	0D	
1" Drop	1D	
2" Drop	2D	
3" Drop	3D	
4" Drop	4D	
5" Drop	5D	
6" Drop	6D	
7" Drop	7D	
Mounting		
<small>(Ceiling grid by others)</small>		
15/16" Layin	G1	
9/16" Layin	G2	
<small>(Consult factory for regular availability)</small>		
Factory Options		
Plenum / Chicago Plenum	CP	
<small>(Contact factory for Flush tile)</small>		
Color		
See page 3 for color offering		

Acoustic Materials



THE NATURALS (25% SCALE)



STANDARD PET



PREMIUM PET

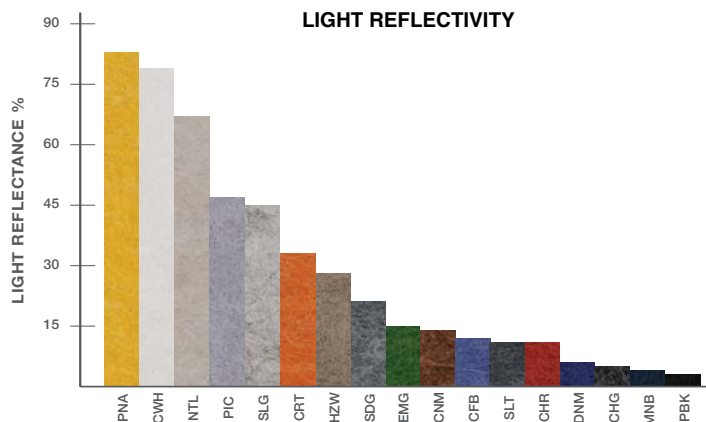

PET
Focal Point, LLC

Final Assembly: Chicago, Illinois, USA
Life Expectancy: 30 Year(s)
End of Life Options: Salvageable/Reusable in its Entirety, Recyclable (100%)

Ingredients:

Polyethylene terephthalate: PET; **N, N'-Ethylene bisstearamide:** Octadecanamide, N,N'-1,2-ethanediybis-; **Stearic Acid:** Stearic Acid; **Antioxidant 1076:** Benzenepropanoic acid, 3,5-bis(1,1-dimethylethyl)-4-hydroxy-, octadecyl ester; **Antioxidant KY-405:** Benzenamine, 4-(1-methyl-1-phenylethyl)-N-[4-(1-methyl-1-phenylethyl)phenyl]; **Titanium Dioxide:** Titanium dioxide

Living Building Challenge Criteria:

I-13 Red List:

- LBC Red List Free
- LBC Red List Approved
- Declared

% Disclosed: 100% at 100ppm
VOC Content: Not Applicable

I-10 Interior Performance: Not Compliant
I-14 Responsible Sourcing: Not Applicable

FPL-0001
EXP. 01 APR 2025
Original Issue Date: 2020

INTERNATIONAL LIVING FUTURE INSTITUTE™ living-future.org/declare