

A brand of  legrand



FOCAL POINT®



# TruTile™

MODULAR ACOUSTIC WALL TILES



# TruTile™

Easily transition from ceiling to walls with TruTile™. The modular, 2'x2' acoustic wall tiles support the creation of unique accent walls and bespoke wall art pieces that infuse spaces with beauty and enhance occupants' comfort.

Mix and match various standard TruTile Designs, Textures, and Shapes and play with tile orientation to create unique patterns. TruTile offers a coordinated look with our other acoustic solutions using a shared PET felt color palette and The Naturals collection of five nature-inspired finishes.

Easily source ceiling and wall acoustic solutions for your projects from a single, vertically integrated manufacturer that provides peace of mind at every step, from design to manufacturing.

TruTile, curiosity at your fingertips.





# TruTile

## DESIGNS

Curvaceous and linear designs intended for vertical or horizontal installation on walls.

Play with tile design and orientation to create a myriad of bespoke installations.



**Wide Rule**  
(Berry)



**Wide Slant**  
(Slate)

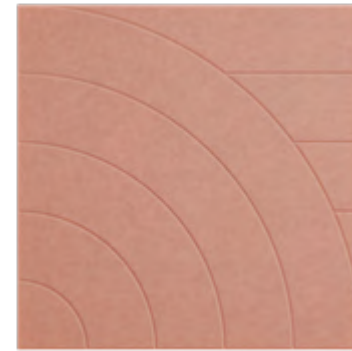

**Wide Arc**  
(Blush)



**Multitrack**  
(Shadow Gray)



**Double Arc**  
(Seafoam)



**Diamond**  
(Limestone)



**Willow**  
(The Naturals - Walnut)



Wide Arc - Vertical pattern in Walnut





Wide Rule & Wide Slant - Alternating pattern in Slate

Wide Arc - Verical pattern in Berry





Multitrack - Vertical pattern in Midnight Blue



Multitrack - Alternating pattern in Midnight Blue





Double Arc - Wave pattern in Seafoam

Double Arc - Organic pattern in Deep Water





**Diamond** - Vertical Brick pattern in Limestone

**Willow** - Vertical pattern in Hazelwood



# TruTile

## TEXTURES

Deeper textural designs capture light and the attention of the viewer.

A quick, easy, and budget-friendly way to transform spaces.



**Pinwale**  
(The Naturals - Walnut)

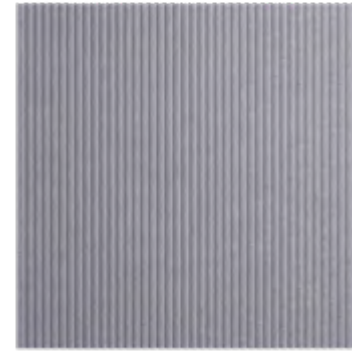

**Feathercord**  
(Pearl Ice)



**Lattice**  
(Shadow Gray)

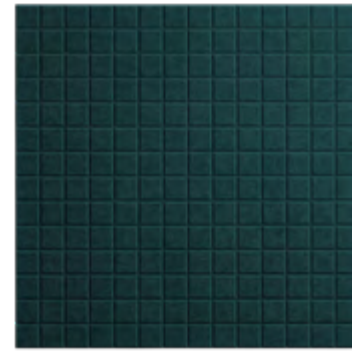

**Grid 49**  
(Deep Water)



Pinwale & Feathercord - Vertical pattern in Pearl Ice



# TruTile

## SHAPES

Organic shapes intended to fluidly nestle.

Part wall art, part wall covering, all beauty and noise control.



**Gem**  
(Shadow Gray)



**Scallop**  
(The Naturals - Light Oak)



**Star**  
(Cherry Red)



Scallop - Lantern pattern in Cornflower & Denim Blue





Scallop - Vertical pattern in Blush & Light Oak

Scallop - Vertical pattern in Cornflower, Classic White, Blush, Pineapple, Seafoam, Denim Blue & Cherry Red





**Gem** - Braid pattern in Limestone & Emerald Green

**Star** - Vertical pattern in Cherry Red



# ACOUSTIC MATERIALS

## THE NATURALS (25% SCALE)



## STANDARD PET

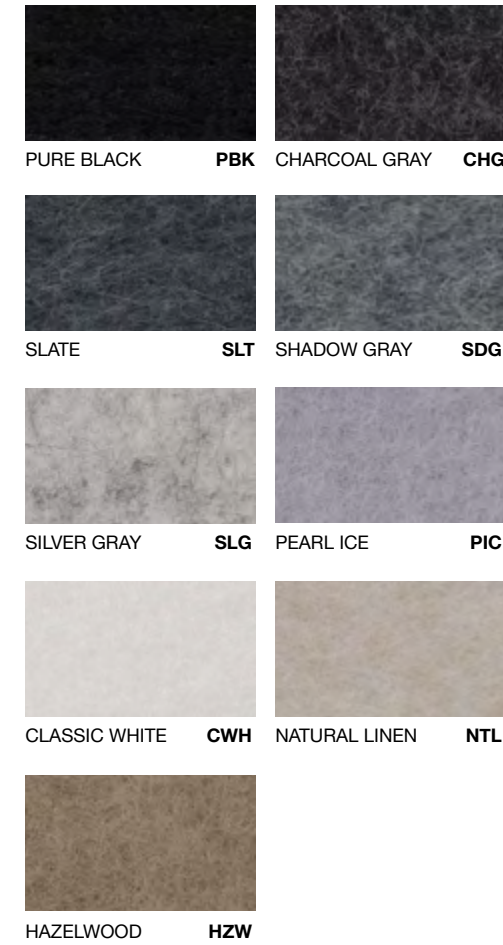

## PREMIUM PET

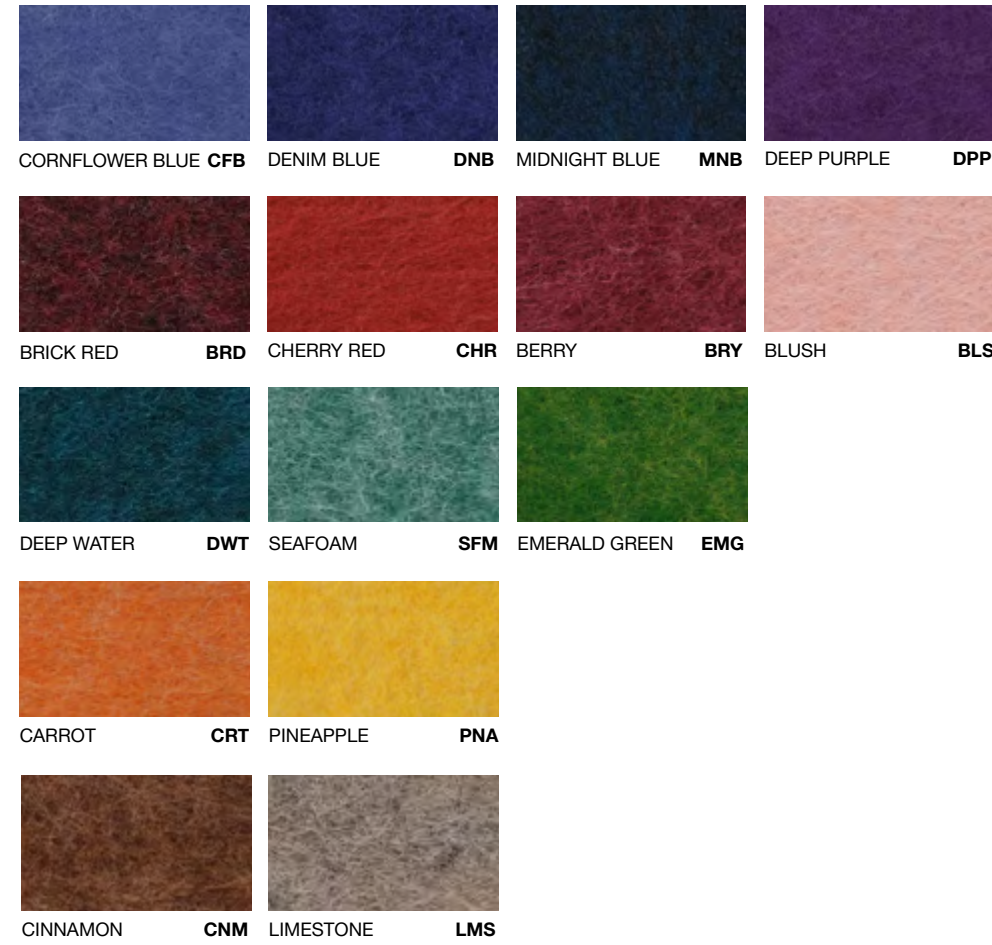

# SPECIFICATIONS

## Acoustic Material

Content	Material is 100% polyester containing up to 50% of recycled plastic bottles (PET felt) and is moisture resistant. See Acoustic Materials page for color offering. Colors are subject to change without notice. For the most current color options, please visit focalpointlights.com/acousticsolutions. Lead times vary depending on color.
Cleaning and Care	Remove dust and debris with a clean, soft, lint-free cloth or vacuum
PET Thickness	9mm
Surface Burning Characteristics	ASTM E84 Class A / CAN ULC S102 Flame Spread: 0 Smoke Development Index: 300

## Acoustic Performance

Acoustic testing is performed on all Focal Point acoustic products and varies based on installation and configuration. ASTM C423 test reports can be downloaded from focalpointlights.com. Contact acoustic.solutions@focalpointlights.com for technical questions.

NRC	Noise Reduction Coefficient (NRC) is the average of how absorptive a material is at various frequencies within the human speech frequency range. Two materials with the same rating may not perform the same in application. Typically, an NRC of 0 indicates perfect reflection, and an NRC of 1 is designated as perfect absorption. However, based on the testing methodology and depending upon the material's shape or surface area products can test at an NRC greater than 1. <b>NRC = 0.30</b>
-----	--

## Light Reflectivity

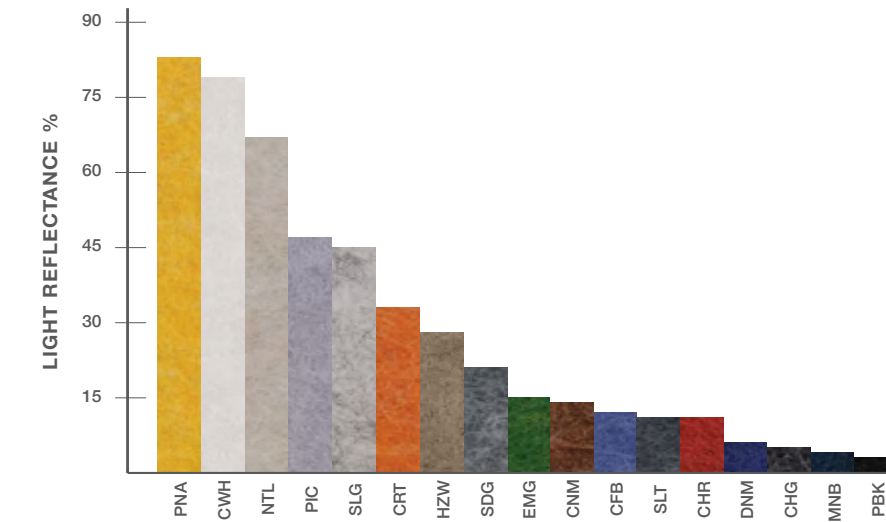

## Weight

1.8 lbs per tile. Ships up to (12) twelve per box = 25.25" x 25.25" x 5".

## Dimensions

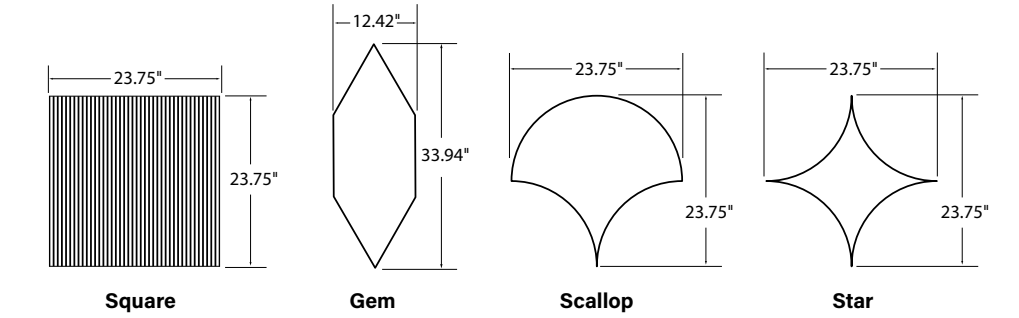

## Reliability

At Focal Point, our products are designed to stand the test of time. Each product is engineered using superior components, manufactured with the utmost care and rigorously tested.

## Warranty

1-year limited warranty.



**FRONT COVER**

Wide Rule & Wide Arc - New deco pattern in Blush

**PAGES 1 & 2**

Multitrack - Vertical pattern in Light Oak with Skydome Edge in White & Light Oak

**BACK COVER**

Double Arc - Organic pattern in Midnight Blue

