

Seem® 4

LED DIRECT/INDIRECT WALL MOUNT

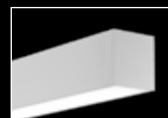

flush lens
top & bottom

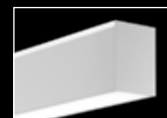

0.5" pop-up lens /
flush lens bottom



linear suspended
companion

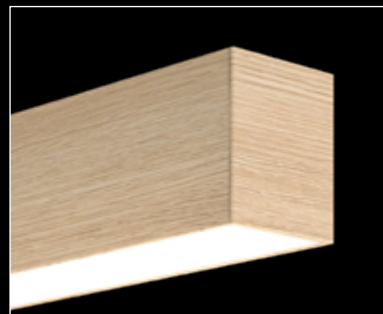

The Naturals collection - Light Oak shown

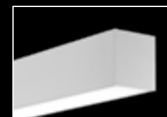

direct only
companion



wall to ceiling
corner companion

DIMENSIONAL DATA

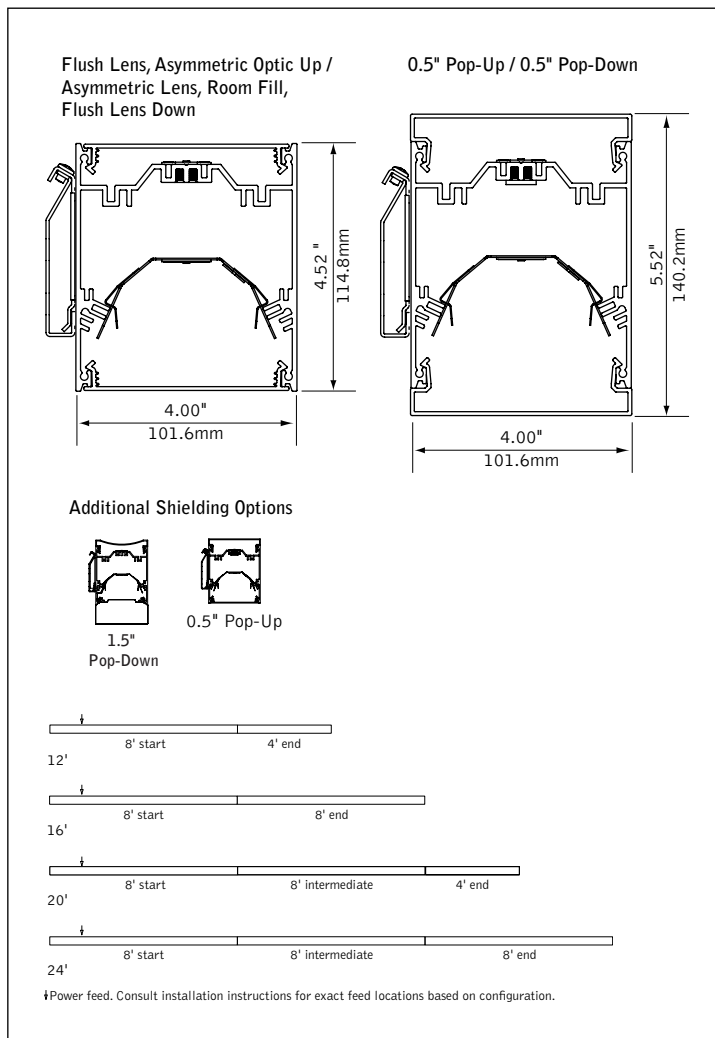

FEATURES

Narrow extruded aluminum 4" direct/indirect wall mount LED Pop-lens options.

Individual units and continuous runs in 1' increments.

Frosted acrylic lenses provide uninterrupted illumination, without pixels or shadows.

LED position and lens material optimized to provide the perfect blend of high performance and visual comfort.

Choice of output levels and light distributions to meet a wide variety of application needs.

PoE compatible: Integrates with Power over Ethernet lighting systems via standard, low-voltage wires.

Tunable White: Supports human activity, well-being, and preferences with a light quality that evolves throughout the day.

Available with The Naturals, a series of finishes that exude biophilic beauty.

PERFORMANCE

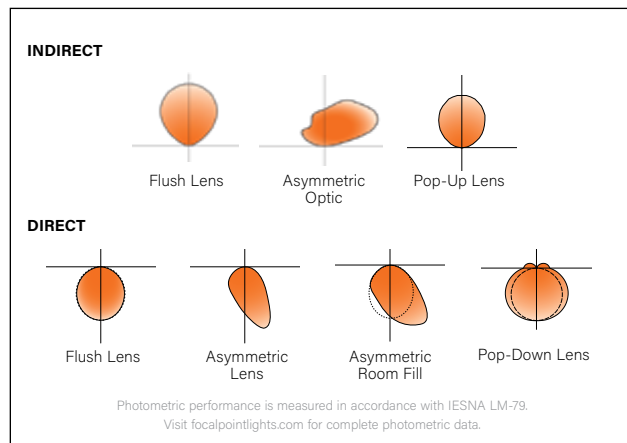

fixture:

project:

DETAILS

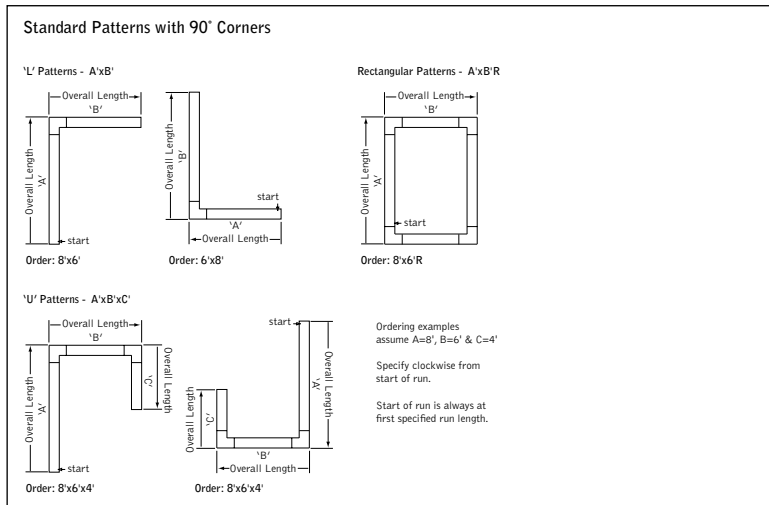

DIRECT ASYMMETRIC
Standard Application Example

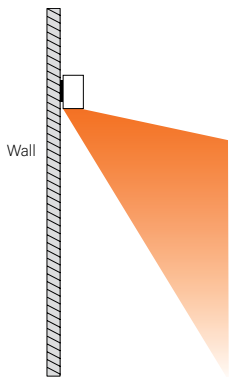

DIRECT ASYMMETRIC ROOM FILL
Standard Application Example

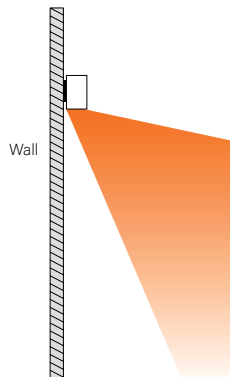

Asymmetric Room Fill Lens
The asymmetric room fill optic projects light into the space to evenly illuminate horizontal planes. It is ideal to light rooms and corridors from the perimeter, resulting in superior efficacy and uniformity on the floor.

STANDARD WHITE

Luminaire Series

FSM4BW

Seem 4 Direct/Indirect LED FSM4BW

Shielding

(Combine Indirect and Direct options to create a single code.)

Indirect/Top Shielding Options

Asymmetric Optic AS
Flush Lens FL
0.5" Pop-Up Lens PU

Direct/Bottom Shielding Options

Asymmetric Lens AS
Asymmetric Room Fill AF
Flush Lens Bottom FL
0.5" Pop-Down Bottom PD05

Direct Distribution

275 Lumens per foot 275DN
375 Lumens per foot 375DN
625 Lumens per foot 625DN
875 Lumens per foot 875DN
1000 Lumens per foot* 1000DN
1125 Lumens per foot* 1125DN
1250 Lumens per foot* 1250DN

*(Not available with Pop Down Lens)

Indirect Distribution

275 Lumens per foot 275UP
375 Lumens per foot 375UP
625 Lumens per foot 625UP
875 Lumens per foot 875UP
1000 Lumens per foot 1000UP
1125 Lumens per foot* 1125UP
1250 Lumens per foot* 1250UP

*(Not available with Pop-Up or Pop-Down Lenses)

Color Temperature

2700K, 80+ CRI or 2700K, 90+ CRI 27K or 927K
3000K, 80+ CRI or 3000K, 90+ CRI 30K or 930K
3500K, 80+ CRI or 3500K, 90+ CRI 35K or 935K
4000K, 80+ CRI or 4000K, 90+ CRI 40K or 940K

Circuits & Zones

1 Circuit, non-emergency 1C
2 non-emergency circuits provide independent control of Direct and Indirect sources 2C

Consult Ordering Guide for multiple circuiting and zoning options

Voltage

120/277 UNV Volt UNV
Low Voltage LV

Control System & Dimming Level

0-10V - 10% Dimming LD1
0-10V - 1% Dimming L11
Low Voltage, PoE compatible LVN

(No driver. Not available with EM or EC. LV Voltage only.)

Lutron Hi-Lume EcoSystem (LDE1) - LH1
1% Dimming
DALI - 1% Dimming D11
(625 lumens per foot max.)

Mounting

Wall Mount WM

Factory Options

(See Ordering Guide for ordering details for DC, EC, EM & ECD.)

Daylight Circuit _DC

Emergency Circuit _EC

Emergency Battery Pack† _EM

Emergency Control Device† _ECD

†(4' minimum. 120/277 Volt Only. EM or ECD not available at corners.)

Finish

(See finishes page for The Naturals options)

Black BK

Titanium Silver TS

Matte White Housing WH

Luminaire Length

(3' minimum length. Leave blank for patterns. Lengths are nominal)

Specify luminaire/row length in ' increments X'

(Smaller increments available. Consult factory.)

Pattern Options

'L' pattern (5' minimum length) A' x B'
'U' pattern (7' minimum length) A' x B' x C'
Rectangular pattern (7' minimum length) A' x B'R

(Consult factory for other pattern options)



Options in orange qualify for the Quickship program. Run lengths in ' increments, 1000' total. Refer to Quickship Guide for complete details.

DETAILS

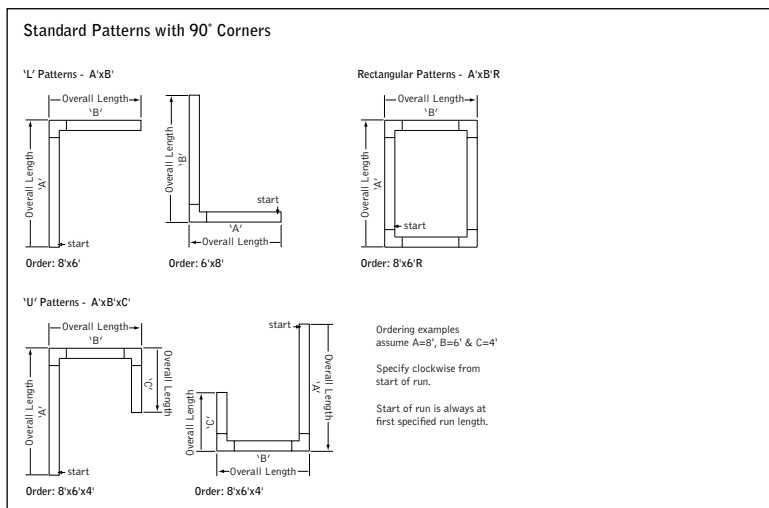

SPECIFICATIONS

LED System

Proprietary linear LED module incorporates premium LEDs on a robust platform to achieve excellent thermal management. LEDs are placed to promote a uniform appearance. Available in 3000K, 3500K or 4000K with >80 or 90 CRI, 3 SDCM or Tunable White (2700K-6500K), CRI>80, >90. 3500K and 4000K with CRI>90 have a cyanosis observation index (COI) of 3.3 or less. LED modules and drivers are replaceable from below.

Construction

One piece extruded aluminum housing. Die cast aluminum end caps.
3' unit weight: 14.5lbs., 4' unit weight: 19lbs., 5' unit weight: 25lbs.

Optic

Reflectors fabricated of 22 Ga. steel finished in High Reflectance White powder coat. Extruded acrylic lens .085" thick with satin finish, up to 8' continuous.

Electrical

Luminaires are pre-wired with factory installed branch circuit wiring and over-molded quick connects. Standard 120-277V constant current driver includes 0-10V analog dimming. Dimming range 100% to 10%. Power factor > .9. PoE compatible: Integrates with Power over Ethernet lighting systems via standard, low-voltage wires. PoE runs require an independent PoE node and power feed for each luminaire section.

Emergency Battery

Bodine BSL310LP. Emergency output - 10 watts for 90 minutes.
Maximum mounting height: 14.12ft

Labels

UL and cUL listed. Suitable for Dry or Damp Locations, indoor use only.

Finish

Polyster powder coat applied over a multi-stage pre-treatment. The Naturals: 100% low VOC vinyl.

Lumen Maintenance

Reported: L70 at >61,000 hours Calculated: L70 at 395,000 hours
Reported: L90 at >61,000 hours Calculated: L90 at 100,000 hours
Derived from EPA TM-21 calculator. Based on typical conditions, consult factory for additional data.

Reliability

At Focal Point, our products are designed to stand the test of time. Each luminaire is engineered using superior components, manufactured with the utmost care and rigorously tested. Contact us for reliability data.

Warranty

LED system rated for operation in ambient environments up to 25°C. 5 year limited warranty.



TUNABLE WHITE

Luminaire Series

Seem 4 Direct/Indirect LED **FSM4BW**

Shielding

(Combine Indirect and Direct options to create a single code.)

Indirect/Top Shielding Options | Flush Lens FL
0.5" Pop-Up Lens PU

Direct/Bottom Shielding Options | Flush Lens Bottom FL
0.5" Pop-Down Bottom PD05

Direct Distribution

275 Lumens per foot 275DN
(4' min with FLFL or PUFL)
375 Lumens per foot 375DN
625 Lumens per foot 625DN
875 Lumens per foot 875DN
1000 Lumens per foot* 1000DN
1125 Lumens per foot* 1125DN

*(Not available with Pop Down Lens)

Indirect Distribution

275 Lumens per foot 275UP
375 Lumens per foot 375UP
625 Lumens per foot 625UP
875 Lumens per foot 875UP
1000 Lumens per foot 1000UP
1125 Lumens per foot 1125UP

(Not available with Pop-Up or Pop-Down lenses)

Color Temperature

Tunable White: 2700-6500K, 80+ CRI 2765T
Tunable White: 2700-6500K, 90+ CRI 92765T

Circuits & Zones

1 Circuit, non-emergency 1C
2 non-emergency circuits provide independent control of Direct and Indirect sources 2C
Consult Ordering Guide for multiple circuiting and zoning options _C_Z_DL

Voltage

120/277 UNV Volt UNV

Control System & Dimming Level

DALI - 1% Dimming D1TW
(Default driver offers DT6 control. It requires two addresses, one for intensity & one for CCT tuning. Consult factory for DT8. Extended lead time applies.)

Mounting

Wall Mount WM

Factory Options

(See Ordering Guide for ordering details for DC, EC, EM & ECD.)

Daylight Circuit _DC

Emergency Circuit _EC

Emergency Battery Pack¹ _EM

Emergency Control Device¹ _ECD

¹(Consult factory)

Finish

(See finishes page for The Naturals options)

Black BK

Titanium Silver TS

Matte White Housing WH

Luminaire Length

(3' minimum length. Leave blank for patterns. Lengths are nominal)

Specify luminaire/row length in 1' increments X'

(Smaller increments available. Consult factory.)

Pattern Options













'L' pattern (5' minimum length) A' x B'

'U' pattern (7' minimum length) A' x B' x C'

Rectangular pattern (7' minimum length) A' x B'R

(Consult factory for other pattern options)

4' PERFORMANCE CHART

Direct Distribution	Indirect Distribution	Distribution % (Direct/Indirect)	Total Nominal Lumens	Tested System Watts	Lumens Per Watt (LPW)									Tested System Watts	Lumens Per Watt (LPW)		
																	
					ASAS	ASAF	ASFL	FLAS	FLAF	FLFL	PUAS	PUAF	PUFL		ASP05	FLPD05	PUPD05
275DN	275	50/50	2200	18.2	137	136	132	132	131	128	123	123	119	21.2	118	110	108
	375	42/58	2600	20.8	144	143	139	138	137	133	124	124	121	23.8	126	117	111
	625	31/69	3600	27.9	146	146	143	138	138	135	122	121	119	30.9	132	122	112
	875	24/76	4600	36.0	147	146	144	138	137	135	120	119	118	39.0	136	125	112
	1000	22/78	5100	40.0	147	146	144	137	137	135	119	118	117	43.0	137	126	112
	1125	20/80	5600	44.0	146	146	144	136	136	134	—	—	—	47.0	137	126	—
	1250	18/82	6100	46.9	135	135	133	135	135	134	—	—	—	49.9	128	129	—
375DN	275	58/42	2600	21.2	141	140	135	137	136	131	129	128	124	25.4	117	108	108
	375	50/50	3000	23.8	147	146	141	141	140	136	129	128	124	28.0	123	114	110
	625	38/62	4000	30.9	148	147	144	141	140	137	125	125	122	35.1	130	120	112
	875	30/70	5000	39.0	146	148	145	140	139	137	123	122	120	43.2	133	123	112
	1000	27/73	5500	43.0	148	148	145	139	139	136	121	121	119	47.1	134	124	112
	1125	25/75	6000	47.0	148	147	145	138	138	135	—	—	—	51.2	135	124	—
	1250	23/77	6500	49.9	137	136	134	137	137	135	—	—	—	54.1	126	126	—
625DN	275	69/31	3600	30.1	139	138	132	136	135	129	130	129	124	38.5	111	102	105
	375	63/37	4000	32.6	144	142	137	139	138	133	130	129	124	41.1	116	107	107
	625	50/50	5000	39.8	145	144	140	139	138	134	127	126	123	48.2	122	112	109
	875	42/58	6000	47.8	146	145	141	139	138	135	124	124	121	56.3	126	116	109
	1000	38/62	6500	51.8	146	145	141	138	138	134	123	123	120	60.2	127	117	109
	1125	36/64	7000	55.9	146	145	141	138	137	134	—	—	—	64.3	128	117	—
	1250	33/67	7500	58.8	136	136	133	137	136	133	—	—	—	67.2	122	120	—
875DN	275	76/24	4600	39.1	138	136	130	135	134	128	130	129	123	49.3	106	98	102
	375	70/30	5000	41.7	141	139	133	138	136	130	130	129	124	51.9	110	102	104
	625	58/42	6000	48.8	143	142	136	138	137	132	128	127	122	59.0	116	107	106
	875	50/50	7000	56.9	144	143	138	138	137	133	125	125	121	67.1	120	110	107
	1000	47/53	7500	60.8	144	143	138	137	137	133	124	123	120	71.0	121	111	107
	1125	44/56	8000	64.9	144	143	139	137	136	132	—	—	—	75.1	122	112	—
	1250	41/59	8500	67.8	136	135	132	136	135	132	—	—	—	78.0	123	113	—
1000DN	275	78/22	5100	43.7	136	135	128	134	133	126	130	129	123	—	—	—	—
	375	73/27	5500	46.2	138	138	132	137	135	129	130	129	123	—	—	—	—
	625	62/38	6500	53.4	140	140	134	137	136	131	128	127	122	—	—	—	—
	875	53/47	7500	61.4	141	141	136	137	136	131	125	125	121	—	—	—	—
	1000	50/50	8000	65.4	141	142	137	137	136	131	124	124	120	—	—	—	—
	1125	47/53	8500	69.5	141	142	137	136	135	131	—	—	—	—	—	—	—
	1250	44/56	9000	72.4	135	134	131	135	135	131	—	—	—	—	—	—	—
1125DN	275	80/20	5600	48.3	135	134	127	133	132	125	129	128	122	—	—	—	—
	375	75/25	6000	50.9	138	136	130	135	134	127	129	128	122	—	—	—	—
	625	64/36	7000	58.0	140	138	133	136	135	129	127	126	121	—	—	—	—
	875	56/44	8000	66.0	141	140	135	136	135	130	125	124	120	—	—	—	—
	1000	53/47	8500	70.0	141	140	135	136	135	130	124	123	119	—	—	—	—
	1125	50/50	9000	74.1	141	140	135	135	134	130	—	—	—	—	—	—	—
	1250	47/53	9500	77.0	135	134	130	135	134	130	—	—	—	—	—	—	—
1250DN	275	82/18	6100	52.1	122	122	119	135	121	117	118	118	114	—	—	—	—
	375	77/23	6500	54.7	125	125	121	136	123	120	119	119	115	—	—	—	—
	625	67/33	7500	61.8	128	128	125	137	125	122	118	118	115	—	—	—	—
	875	59/41	8500	69.9	130	130	127	137	126	123	118	118	115	—	—	—	—
	1000	56/44	9000	73.8	131	131	128	137	127	124	117	117	115	—	—	—	—
	1125	53/47	9500	77.9	131	132	129	136	127	124	—	—	—	—	—	—	—
	1250	50/50	10000	80.8	126	126	124	136	127	124	—	—	—	—	—	—	—

*Based on 3500K, 80CRI, 4' lengths. *Lumen output may vary +/- 5%. Actual wattage may vary +/- 5%. Pop-Up Lens/Pop-down lens lumen output may vary +/- 5%

TW 4' PERFORMANCE CHART

Direct Distribution	Indirect Distribution	Distribution % (Direct/Indirect)	Total Nominal Lumens	Lumens Per Watt (LPW)				Lumens Per Watt (LPW)			
				FLFL		PUFL		FLPD05		PUPD05	
				Tested System Watts ¹		Tested System Watts ¹		Tested System Watts ¹		Tested System Watts ¹	
275	275	50/50	2200	20.4	108	21.9	101	22.8	97	24.2	91
	375	42/58	2600	23.7	110	26.2	99	26.0	100	28.6	91
	625	31/69	3600	33.1	109	37.5	96	35.4	102	39.9	90
	875	24/76	4600	42.8	107	49.5	93	45.2	102	51.8	89
	1000	22/78	5100	47.5	107	55.0	93	49.8	102	57.3	89
	1125	20/80	5600	52.5	107	—	—	54.8	102	—	—
375	1250	18/82	6100	57.5	106	—	—	59.8	104	—	—
	275	58/42	2600	24.1	108	25.6	102	27.9	93	29.4	89
	375	50/50	3000	27.4	109	29.9	100	31.2	96	33.7	89
	625	38/62	4000	36.8	109	41.2	97	40.6	99	45.0	89
	875	30/70	5000	46.5	107	53.2	94	50.3	99	57.0	88
	1000	27/73	5500	51.2	108	58.7	94	54.9	100	62.5	88
625	1125	25/75	6000	56.2	107	—	—	60.0	100	—	—
	1250	23/77	6500	61.2	106	—	—	65.0	102	—	—
	275	69/31	3600	34.6	104	36.1	100	41.4	87	42.8	84
	375	63/37	4000	37.9	106	40.4	99	44.6	90	47.2	85
	625	50/50	5000	47.2	106	51.7	97	54.0	93	58.5	86
	875	42/58	6000	57.0	105	63.6	94	63.8	94	70.4	85
875	1000	38/62	6500	61.6	105	69.2	94	68.4	95	75.9	86
	1125	36/64	7000	66.7	105	—	—	73.4	95	—	—
	1250	33/67	7500	71.6	105	—	—	78.4	96	—	—
	275	76/24	4600	45.6	101	47.0	98	55.7	83	57.2	80
	375	70/30	5000	48.9	102	51.4	97	59.0	85	61.5	81
	625	58/42	6000	58.2	103	62.7	96	68.4	88	72.8	82
1000	875	50/50	7000	68.0	103	74.6	94	78.1	90	84.8	83
	1000	47/53	7500	72.6	103	80.2	94	82.8	91	90.3	83
	1125	44/56	8000	77.7	103	—	—	87.8	91	—	—
	1250	41/59	8500	82.6	103	—	—	92.8	92	—	—
	275	78/22	5100	50.9	100	52.3	98	—	—	—	—
	375	73/27	5500	54.1	102	56.7	97	—	—	—	—
1125	625	62/38	6500	63.5	102	68.0	96	—	—	—	—
	875	53/47	7500	73.3	102	79.9	94	—	—	—	—
	1000	50/50	8000	77.9	103	85.4	94	—	—	—	—
	1125	47/53	8500	82.9	103	—	—	—	—	—	—
	1250	44/56	9000	87.9	102	—	—	—	—	—	—
	275	80/20	5600	56.6	99	58.0	97	—	—	—	—
1250	375	75/25	6000	59.8	100	62.3	96	—	—	—	—
	625	64/36	7000	69.2	101	73.7	95	—	—	—	—
	875	56/44	8000	79.0	101	85.6	93	—	—	—	—
	1000	53/47	8500	83.6	102	91.1	93	—	—	—	—
	1125	50/50	9000	88.6	102	—	—	—	—	—	—
	1250	47/53	9500	93.6	102	—	—	—	—	—	—
1250	275	90/10	6100	62.4	98	63.8	96	—	—	—	—
	375	85/15	6500	65.6	99	68.2	95	—	—	—	—
	625	73/27	7500	75.0	100	79.5	94	—	—	—	—
	875	65/35	8500	84.8	100	91.4	93	—	—	—	—
	1000	61/39	9000	89.4	101	96.9	93	—	—	—	—
	1125	58/42	9500	94.4	101	—	—	—	—	—	—
1250	55/45	10000	99.4	101	—	—	—	—	—	—	

Lumen Multipliers

CRI	Multiplier
80+	1.16
90+	1.00

Wattage Multipliers

CCT	Multiplier
2700K	1.00
3000K	0.96
3500K	0.92
4000K	0.89
5000K	0.88
5700K	0.87

¹Based on 2700K, 90CRI, 4' lengths. *Lumen output may vary +/- 5%. Actual wattage may vary +/- 5%. Pop-Up Lens/Pop-down lens lumen output may vary +/- 5%

Finishes



STANDARD FINISHES



WHITE WH BLACK BK TITANIUM SILVER TS

THE NATURALS (25% SCALE)



LIGHT OAK LOK GRAY ELM GRE CHESTNUT CHT WALNUT WLT WOVEN LINEN WLN

Declare.

Seem Linear Luminaires Focal Point, LLC

Final Assembly: Chicago, IL, USA
Life Expectancy: 10 Year(s)
End of Life Options: Recyclable (55%), Landfill (45%)

Ingredients:

Aluminum Alloy 6063; UNS G10080 Steel Alloy; Small Electrical Components - RoHS Compliant¹; Copper; Polymethyl methacrylate; Steel; Poly[imino(1,6-dioxo-1,6-hexanediy)imino-1,6-hexanediy]; Polyvinyl chloride; Aluminum Alloy 6061; UNS S30400 Stainless Steel Alloy; Steel manufacture, chemicals; 2-Propenoic acid, 2-methyl-, methyl ester, polymer with ethyl 2-propenoate; Nylon 6; Benzene, ethenyl-, homopolymer, brominated; Bis(pentabromophenyl) ether (decabromodiphenyl ether) (DecaBDE); Tris(2-ethylhexyl) trimellitate; Zinc; Methyl methacrylate; Antimony oxide (Antimony trioxide); Kaolin, calcined; Octadecanoic acid, calcium salt; Steel, carbon

¹LBC Temp Exception RL-002 - Small Electrical Components

Living Building Challenge Criteria:

I-13 Red List:

- LBC Red List Free
- LBC Red List Approved
- Declared
- % Disclosed: 100% at 100ppm
- VOC Content: Not Applicable

I-10 Interior Performance: Not Applicable
I-14 Responsible Sourcing: Not Applicable

FPL-0003
 EXP. 01 FEB 2027
 Original Issue Date: 2024

MANUFACTURER RESPONSIBLE FOR LABEL ACCURACY
 INTERNATIONAL LIVING FUTURE INSTITUTE™ living-future.org/declare

Exclusions: Pop-Up & Pop-Down Lenses, Emergency Battery Pack (EM), The Naturals collection finishes