

Seem[®] 2

LED PERIMETER

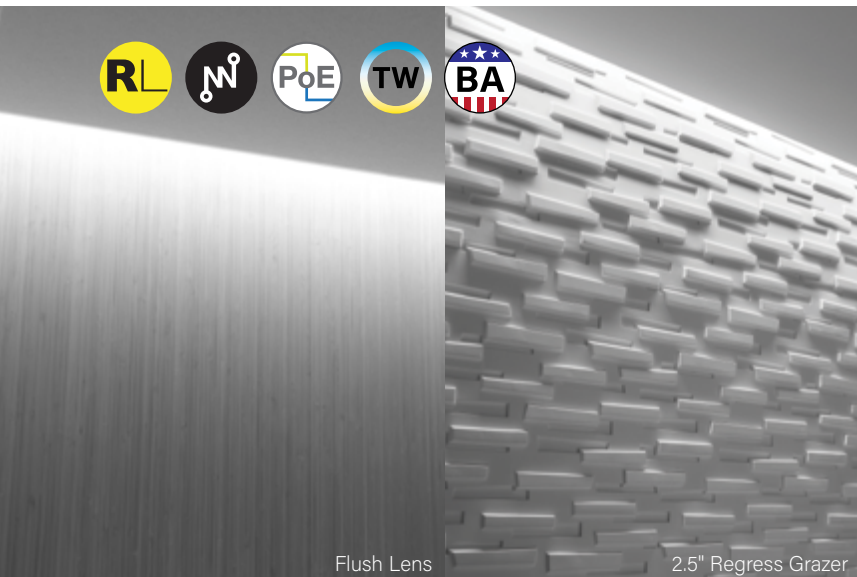

Flush Lens

2.5" Regress Grazer



recessed companion



wall to ceiling companion



wall mount companion

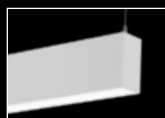

suspended companion

DIMENSIONAL DATA

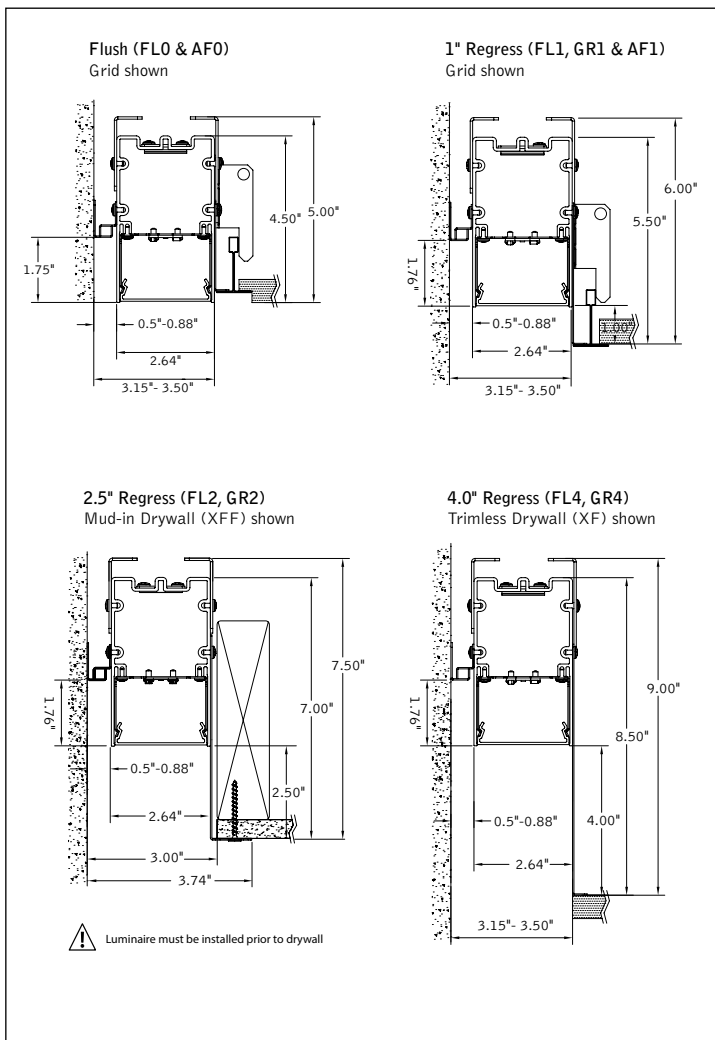

FEATURES

Seem 2 LED perimeter provides a glowing transition between ceiling and wall with flush, 1" regress, 2.5" regress or 4.0" regress lenses.

Easy +/- 3 inch post-installation adjustability for continuous wall-to-wall illumination.

Grazer optic provides even vertical illumination and adds drama to a space by highlighting textured walls and architectural details.

Asymmetric Room Fill optic provides superior efficacy and uniformity to light rooms and corridors from the perimeter.

Tunable White: Supports human activity, well-being, and preferences with a light quality that evolves throughout the day.

Connected Solutions: Integrates with wired and wireless building lighting control systems.

PoE compatible: Integrates with Power over Ethernet lighting systems via standard, low-voltage wires.



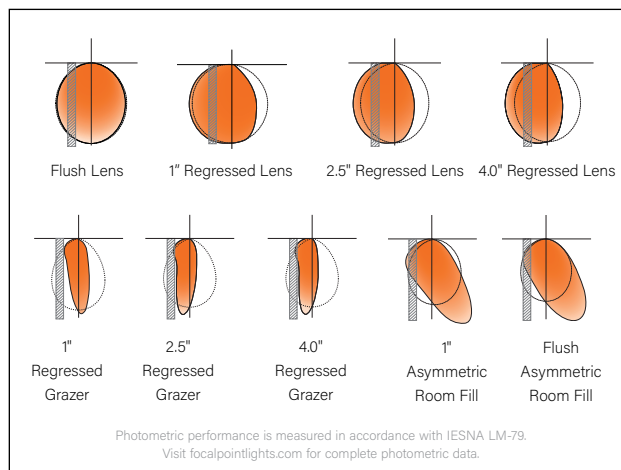

DISTRIBUTIONS

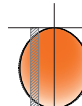
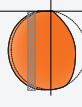
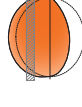

fixture:

project:

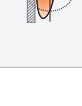
4' PERFORMANCE CHART

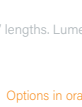
Shielding	Lumen Output	Delivered Lumens	Tested System Watts	LPW
Flush Lens 	125LF	500	5.5	92
	250LF	1000	8.9	112
	375LF	1500	12.2	122
	625LF	2500	20.5	122
	750LF	3000	24.6	122
	875LF	3500	28.9	121
1000LF	4000	33.3	120	
1.0" Regress 	125LF	500	5.6	90
	250LF	1000	9.2	109
	375LF	1500	12.6	119
	625LF	2500	21.3	118
	750LF	3000	25.6	117
	875LF	3500	30.1	116
1000LF	4000	34.7	115	
2.5" Regress 	125LF	500	5.7	88
	250LF	1000	9.5	105
	375LF	1500	13.2	114
	625LF	2500	22.3	112
	750LF	3000	26.9	112
	875LF	3500	31.6	111
1000LF	4000	36.5	110	
4.0" Regress 	125LF	500	5.9	85
	250LF	1000	9.7	103
	375LF	1500	13.9	108
	625LF	2500	23.5	107
	750LF	3000	28.3	106
	875LF	3500	33.4	105
1000LF	4000	38.6	104	
1.0" Regress Grazer 	125LF	500	5.9	85
	250LF	1000	9.5	105
	375LF	1500	13.0	115
	625LF	2500	20.9	120
	750LF	3000	26.0	116
	875LF	3500	30.4	115
1000LF	4000	35.0	114	
2.0" Regress Grazer 	125LF	500	5.9	84
	250LF	1000	9.7	103
	375LF	1500	13.3	113
	625LF	2500	21.4	117
	750LF	3000	26.6	113
	875LF	3500	31.2	112
1000LF	4000	36.0	111	
4.0" Regress Grazer 	125LF	500	5.9	84
	250LF	1000	9.7	103
	375LF	1500	13.4	112
	625LF	2500	22.4	111
	750LF	3000	27.1	111
	875LF	3500	31.8	110
1000LF	4000	36.6	109	
Flush Asymmetric Room Fill 	125LF	500	5.6	89
	250LF	1000	8.5	118
	375LF	1500	11.6	130
	625LF	2500	18.6	134
	750LF	3000	23.1	130
	875LF	3500	27.1	129
1000LF	4000	31.1	129	
1.0" Regress Asymmetric Room Fill 	125LF	500	5.5	90
	250LF	1000	8.7	116
	375LF	1500	11.9	126
	625LF	2500	19.1	131
	750LF	3000	23.8	126
	875LF	3500	27.8	126
1000LF	4000	32.0	125	

Based on 3500K, 80CRI, 4' lengths. Lumen multiplier 90+ CRI = 0.86. Lumen output may vary +/- 5%. Actual wattage may vary +/- 5%

QS 10 DAY Options in orange qualify for the Quickship program. 400' total. Refer to Quickship Guide for complete details.

Focal Point LLC reserves the right to change specifications for product improvement without notification.

STANDARD WHITE

Luminaire Series

Seem 2 LED Perimeter **FSM2PR**

Housing Type

Adjustable Lit Housing

(Allows for +/- 3" adjustment to overall run length. 3' minimum luminaire length. LD1, L11, LVN & D11 only)

Fixed Housing **ALH**

(not recommended for wall to wall installations) **FXH**

Shielding

Flush Lens* **FL0**

1.0" Regress **FL1**

2.5" Regress **FL2**

4" Regress **FL4**

1.0" Regress Grazer **GR1**

2.5" Regress Grazer **GR2**

4.0" Regress Grazer **GR4**

Flush Asymmetric Room Fill* **AF0**

1.0" Regress Asymmetric Room Fill **AF1**

* (Not available with Unlit Sliding Sleeves - SSB)

Lumen Output

125 Lumens per foot **125LF**

(LD1, L11 & D11 only. 4' minimum. Not available with patterns) **250LF**

(3' minimum with LH1. Not available in patterns with LH1) **375LF**

625 Lumens per foot **625LF**

750 Lumens per foot **750LF**

875 Lumens per foot **875LF**

1000 Lumens per foot **1000LF**

Color Temperature

2700K, 80+ CRI or 90+ CRI **27K or 927K**

3000K, 80+ CRI or 90+ CRI **30K or 930K**

3500K, 80+ CRI or 90+ CRI **35K or 935K**

4000K, 80+ CRI or 90+ CRI **40K or 940K**

Circuits & Zones

1 Circuit, non-emergency **1C**

Consult Ordering Guide for multiple circuiting and zoning options **_C_Z_DL**

Voltage

120/277 UNV Volt **UNV**

Low Voltage **LV**

Control System & Dimming Level

0-10V - 10% Dimming **LD1**

0-10V - 1% Dimming **L11**

Low Voltage, PoE compatible **LVN**

(No driver. Not available with EM or EC. LV Voltage only)

Lutron Hi-Lume EcoSystem (LDE1) - 1% Dimming² **LH1**

(Not available with CP) **D11**

DALI 1% Dimming **D11**

Wattstopper PLUS^{1,2,3} **WSPC**

Connected Light Module **WSPS**

Wattstopper PLUS^{1,3} **WSPS**

SensiLUM Wireless Sensor **LAW1**

(Remote mounted sensor. See sensor layout guide)

Lutron Athena Wireless Node^{1,2,3} **LAW1**

(Remote mounted sensor. See sensor layout guide)

Acuity nLight - 1% Dimming^{1,2} **NLT1**

(Not available with CP)

Current NX Enabled - 1% Dimming^{1,2} **NXE1**

(Not available with CP)

WaveLinux Pro - 1% Dimming¹ **WLXP**

(Remote mounted sensor. See sensor layout guide)

¹(3' minimum length. 7' minimum length with FXH & EM. Not available with ALH.) ²(G & ST mounting only)

³(0-10V standard, consult factory for DALI)

Mounting

Grid **G**

Slot Tee / Tegular **ST**

(Flush shieldings only)

Trim Flange Drywall **TF**

(Flush shieldings only)

Trimless Drywall **XF**

(Regress shieldings only)

Mud-in Trimless Drywall **XFF**

Factory Options

(See Ordering Guide for ordering details for DC, EC, EM & ECD.)

Chicago Plenum **CP**

(Not available with Flex Whip)

Daylight Circuit **_DC**

Emergency Circuit **_EC**

Emergency Battery Pack^f **_EM**

Emergency Control Device^f **_ECD**

6' New York City Flex Whip (120V) **FNY1**

6' New York City Flex Whip (277V) **FNY2**

6' Flex Whip **FW**

Unlit Sliding Sleeves **SSB**

(Set of two unlit 12" sleeves. Fixed housing in straight runs only. FL1, FL2, FL4, GR1, GR2 & GR4 only. 3' minimum length.)

Finish

Matte White Housing **WH**

Luminaire Length

Specify luminaire/row length in 1" increments **_ft_in**

(2' minimum length)

Pattern Options

Specify patterns based on wall-to-wall dimensions **PAT**





(See Pattern Configurations for example)

Example: FSM2LPR-ALH-FL2-625LF-35K-1C-120-LD1-G-WH-PAT-10-ICR-20-ICR-10

^f 4' minimum length with EM or ECD. 120/277 Volt only. EM or ECD not available at corners.

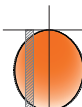
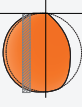
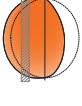

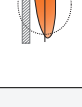
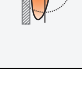
TW 4' PERFORMANCE CHART

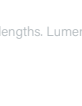
Shielding	Lumen Output	Delivered Lumens	Tested System Watts	LPW
Flush Lens 	125LF	500	6.3	79
	250LF	1000	10.3	97
	375LF	1500	15.6	96
	625LF	2500	26.0	96
	750LF	3000	31.3	96
	875LF	3500	36.7	95
1.0" Regress 	1000LF	4000	42.3	94
	125LF	500	6.4	78
	250LF	1000	10.6	94
	375LF	1500	16.1	93
	625LF	2500	27.0	93
	750LF	3000	32.5	92
2.5" Regress 	875LF	3500	38.2	92
	1000LF	4000	44.0	91
	125LF	500	6.6	76
	250LF	1000	11.1	90
	375LF	1500	16.8	89
	625LF	2500	28.3	88
4.0" Regress 	750LF	3000	34.1	88
	875LF	3500	40.2	87
	1000LF	4000	46.3	86
	125LF	500	6.8	73
	250LF	1000	11.2	89
	375LF	1500	17.6	85
1.0" Regress Grazer 	625LF	2500	29.8	84
	750LF	3000	36.0	83
	875LF	3500	42.4	83
	1000LF	4000	49.0	82
	125LF	500	6.5	77
	250LF	1000	9.9	101
2.0" Regress Grazer 	375LF	1500	14.8	101
	625LF	2500	23.8	105
	750LF	3000	29.6	101
	875LF	3500	34.7	101
	1000LF	4000	39.9	100
	125LF	500	6.4	78
4.0" Regress Grazer 	250LF	1000	10.1	99
	375LF	1500	15.1	99
	625LF	2500	24.4	102
	750LF	3000	30.3	99
	875LF	3500	35.5	99
	1000LF	4000	40.9	98
Flush Asymmetric Room Fill 	125LF	500	6.4	78
	250LF	1000	10.5	95
	375LF	1500	15.8	95
	625LF	2500	26.5	94
	750LF	3000	31.9	94
	875LF	3500	37.4	94
1.0" Regress Asymmetric Room Fill 	1000LF	4000	43.1	93
	125LF	500	6.5	77
	250LF	1000	9.8	102
	375LF	1500	14.7	102
	625LF	2500	23.6	106
	750LF	3000	29.4	102
	875LF	3500	34.4	102
	1000LF	4000	39.5	101
	125LF	500	6.4	78
	250LF	1000	10.0	100
	375LF	1500	15.1	100
	625LF	2500	24.2	103
	750LF	3000	30.2	99
	875LF	3500	35.4	99
	1000LF	4000	40.7	98

Based on 2700K, 90CRI, 4' lengths. Lumen output may vary +/- 5%. Actual wattage may vary +/- 5%

TUNABLE WHITE

Luminaire Series
Seem 2 LED Perimeter **FSM2PR**

Housing Type

Adjustable Lit Housing ALH
(Allows for +/- 3" adjustment to overall run length. 3' minimum luminaire length. LD1, L1, LVN, & D11 only.)

Fixed Housing FXH
(not recommended for wall to wall installations)

Shielding FL0
(Not available with Unlit Sliding Sleeves - SSB)

1.0" Regress FL1

2.5" Regress FL2

4" Regress FL4

1.0" Regress Grazer GR1

2.5" Regress Grazer GR2

4.0" Regress Grazer GR4

Flush Asymmetric Room Fill AF0

1.0" Regress Asymmetric Room Fill AF1
(Not available with Unlit Sliding Sleeves - SSB)

Lumen Output

125 Lumens per foot 125LF

250 Lumens per foot 250LF

375 Lumens per foot 375LF

625 Lumens per foot 625LF

750 Lumens per foot 750LF

875 Lumens per foot 875LF

1000 Lumens per foot 1000LF

(4' minimum. Not available with patterns)

(Not available with Unit Sliding Sleeves - SSB)

(Not available with Unit Sliding Sleeves - SSB)

(Not available with Unit Sliding Sleeves - SSB)

(Not available with Unit Sliding Sleeves - SSB)

(Not available with Unit Sliding Sleeves - SSB)

(Not available with Unit Sliding Sleeves - SSB)

(Not available with Unit Sliding Sleeves - SSB)

(Not available with Unit Sliding Sleeves - SSB)

(Not available with Unit Sliding Sleeves - SSB)

(Not available with Unit Sliding Sleeves - SSB)

(Not available with Unit Sliding Sleeves - SSB)

(Not available with Unit Sliding Sleeves - SSB)

(Not available with Unit Sliding Sleeves - SSB)

(Not available with Unit Sliding Sleeves - SSB)

(Not available with Unit Sliding Sleeves - SSB)

(Not available with Unit Sliding Sleeves - SSB)

(Not available with Unit Sliding Sleeves - SSB)

(Not available with Unit Sliding Sleeves - SSB)

(Not available with Unit Sliding Sleeves - SSB)

(Not available with Unit Sliding Sleeves - SSB)

(Not available with Unit Sliding Sleeves - SSB)

(Not available with Unit Sliding Sleeves - SSB)

(Not available with Unit Sliding Sleeves - SSB)

(Not available with Unit Sliding Sleeves - SSB)

(Not available with Unit Sliding Sleeves - SSB)

(Not available with Unit Sliding Sleeves - SSB)

(Not available with Unit Sliding Sleeves - SSB)

(Not available with Unit Sliding Sleeves - SSB)

(Not available with Unit Sliding Sleeves - SSB)

(Not available with Unit Sliding Sleeves - SSB)

(Not available with Unit Sliding Sleeves - SSB)

(Not available with Unit Sliding Sleeves - SSB)

(Not available with Unit Sliding Sleeves - SSB)

(Not available with Unit Sliding Sleeves - SSB)

(Not available with Unit Sliding Sleeves - SSB)

(Not available with Unit Sliding Sleeves - SSB)

(Not available with Unit Sliding Sleeves - SSB)

(Not available with Unit Sliding Sleeves - SSB)

(Not available with Unit Sliding Sleeves - SSB)

(Not available with Unit Sliding Sleeves - SSB)

(Not available with Unit Sliding Sleeves - SSB)

(Not available with Unit Sliding Sleeves - SSB)

(Not available with Unit Sliding Sleeves - SSB)

(Not available with Unit Sliding Sleeves - SSB)

(Not available with Unit Sliding Sleeves - SSB)

(Not available with Unit Sliding Sleeves - SSB)

(Not available with Unit Sliding Sleeves - SSB)

(Not available with Unit Sliding Sleeves - SSB)

(Not available with Unit Sliding Sleeves - SSB)

(Not available with Unit Sliding Sleeves - SSB)

(Not available with Unit Sliding Sleeves - SSB)

(Not available with Unit Sliding Sleeves - SSB)

(Not available with Unit Sliding Sleeves - SSB)

(Not available with Unit Sliding Sleeves - SSB)

(Not available with Unit Sliding Sleeves - SSB)

(Not available with Unit Sliding Sleeves - SSB)

(Not available with Unit Sliding Sleeves - SSB)

(Not available with Unit Sliding Sleeves - SSB)

(Not available with Unit Sliding Sleeves - SSB)

(Not available with Unit Sliding Sleeves - SSB)

(Not available with Unit Sliding Sleeves - SSB)

(Not available with Unit Sliding Sleeves - SSB)

(Not available with Unit Sliding Sleeves - SSB)

(Not available with Unit Sliding Sleeves - SSB)

(Not available with Unit Sliding Sleeves - SSB)

(Not available with Unit Sliding Sleeves - SSB)

(Not available with Unit Sliding Sleeves - SSB)

Color Temperature
Tunable White: 2700-6500K, 80+ CRI 2765T
Tunable White: 2700-6500K, 90+ CRI 92765T

Circuits & Zones
1 Circuit, non-emergency 1C
Consult Ordering Guide for multiple circuiting and zoning options _C_Z_DL

Voltage
120/277 UNV Volt UNV

Control System & Dimming Level
DALI 1% Dimming D1TW
(Default driver offers DT6 control. It requires two addresses, one for intensity & one for CCT tuning. Consult factory for DT8. Extended lead time applies.)

Mounting
Grid G
Slot Tee / Tegular ST
(Flush shieldings only)
Trim Flange Drywall TF
(Flush shieldings only)
Trimless Drywall XF
(Regress shieldings only)
Mud-in Trimless Drywall XFF

Factory Options
(See Ordering Guide for ordering details for DC, EC, EM & ECD.)
Chicago Plenum CP
(Not available with Flex Whip)
Daylight Circuit _DC
Emergency Circuit _EC
Emergency Battery Pack¹ _EM
Emergency Control Device¹ _ECD
6' New York City Flex Whip (120V) FNY1
6' New York City Flex Whip (277V) FNY2
6' Flex Whip FW
Unlit Sliding Sleeves SSB
(Set of two unlit 12" sleeves. Fixed housing in straight runs only. FL1, FL2, FL4, GR1, GR2 & GR4 only. 3' minimum length.)

Finish
Matte White Housing WH

Luminaire Length
Specify luminaire/row length in 1" increments _ft_in
(2' minimum length)

Pattern Options
Specify patterns based on wall-to-wall dimensions PAT
(See Pattern Configurations for example)

Example: FSM2LPR-ALH-FL2-625LF-2765T-1C-120-D1TW-G-WH-PAT-10-ICR-20-ICR-10

¹ 4' minimum length with EM or ECD. 120/277 Volt only. EM or ECD not available at corners.

Lumen Multiplier		Wattage Multipliers	
CRI	Multiplier	CCT	Multiplier
80+	1.16	2700K	1.00
90+	1.00	3000K	0.96
		3500K	0.92
		4000K	0.89
		5000K	0.88
		5700K	0.87

SPECIFICATIONS

LED System

Proprietary linear LED module incorporates premium LEDs on a robust platform to achieve excellent thermal management. LEDs are placed to promote a uniform appearance. Available in 2700K, 3000K, 3500K or 4000K with CRI>80 or CRI>90, 3 SDCM. 3500K and 4000K with CRI>90 have a cyanosis observation index (COI) of 3.3 or less. LED modules and drivers are replaceable from below.

Construction

One piece extruded aluminum housing. 20 Ga. steel end caps, bulkheads, sliding sleeve and regress leg. 4' unit weight: 17 lbs.

Optic

Reflectors fabricated of 22 Ga. steel finished in High Reflectance White powder coat. Extruded acrylic lens .07" thick with satin finish, up to 8' continuous.

Electrical

Luminaires are pre-wired with factory installed branch circuit wiring and over-molded quick connects. Standard 120-277V constant current driver includes 0-10V analog dimming. Power factor > .9. PoE compatible: Integrates with Power over Ethernet lighting systems via standard, low-voltage wires. PoE runs require an independent PoE node and power feed for each luminaire section.

Emergency Battery

Output - 10 watts for 90 minutes. Maximum mounting height: 17.9ft. Emergency Circuit with Connected Solutions (WSPC, WSPS, NLT1, NXE1, WLXP) shipped standard with leads to connect UL924 compliant device, by others.

Labels

UL and cUL Listed. Suitable for Dry or Damp Locations, indoor use only.

Finish

Polyester powder coat applied over a multi-stage pre-treatment.

Lumen Maintenance

Reported: L70 at >61,000 hours Calculated: L70 at 270,000 hours
 L90 at >61,000 hours L90 at 73,000 hours
(Derived from EPA TM-21 calculator. Based on typical conditions, consult factory for additional data.)

Reliability

At Focal Point, our products are designed to stand the test of time. Each luminaire is engineered using superior components, manufactured with the utmost care and rigorously tested. Contact us for reliability data.

Warranty

LED system rated for operation in ambient environments up to 25°C. 5-year limited warranty.

PATTERN CONFIGURATIONS

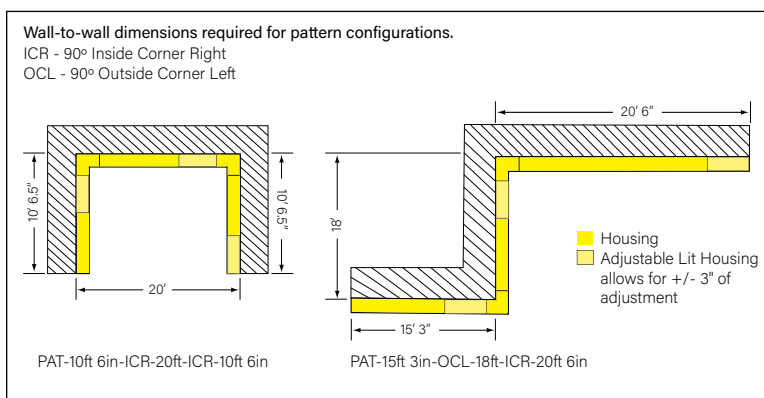

Declare.

Seem Linear Luminaires

Focal Point, LLC

Final Assembly: Chicago, IL, USA
Life Expectancy: 10 Year(s)
End of Life Options: Recyclable (55%), Landfill (45%)

Ingredients:

Aluminum Alloy 6063; UNS G10080 Steel Alloy; Small Electrical Components - RoHS Compliant; Copper; Polymethyl methacrylate; Steel; Poly[imino(1,6-dioxo-1,6-hexanediy)imino-1,6-hexanediy]; Polyvinyl chloride; Aluminum Alloy 6061; UNS S30400 Stainless Steel Alloy; Steel manufacture, chemicals; 2-Propanoic acid, 2-methyl-, methyl ester, polymer with ethyl 2-propanoate; Nylon 6; Benzene, ethenyl-, homopolymer, brominated; Bis(pentabromophenyl) ether (decabromodiphenyl ether) (DecaBDE); Tris(2-ethylhexyl) trimellitate; Zinc; Methyl methacrylate; Antimony oxide (Antimony trioxide); Kaolin, calcined; Octadecanoic acid, calcium salt; Steel, carbon

LBC Temp Exception RL-002 - Small Electrical Components

Living Building Challenge Criteria:

I-13 Red List:
 LBC Red List Free % Disclosed: 100% at 100ppm
 LBC Red List Approved VOC Content: Not Applicable
 Declared

I-10 Interior Performance: Not Applicable
I-14 Responsible Sourcing: Not Applicable

FPL-0003
EXP. 01 FEB 2027
Original Issue Date: 2024

MANUFACTURER RESPONSIBLE FOR LABEL ACCURACY
INTERNATIONAL LIVING FUTURE INSTITUTE™ living-future.org/declare

DIMENSIONAL DATA (continued)

FLUSH	1" REGRESS	2.5" REGRESS	4" REGRESS
-------	------------	--------------	------------

LAY-IN GRID (G)

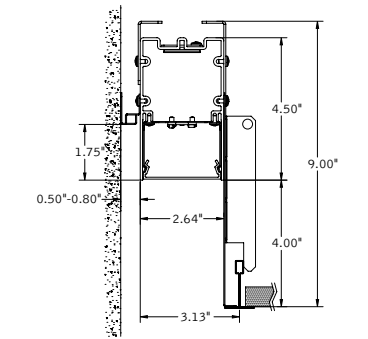
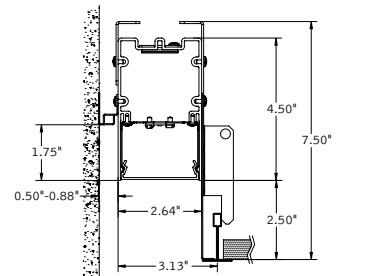
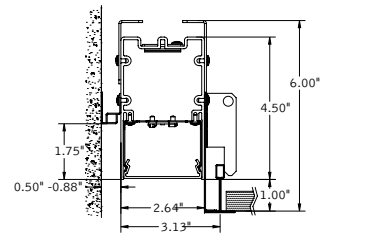
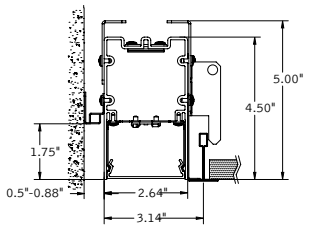

SLOT TEE/TEGULAR (ST)

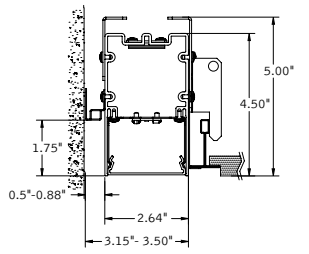

MUD-IN DRYWALL (XFF)

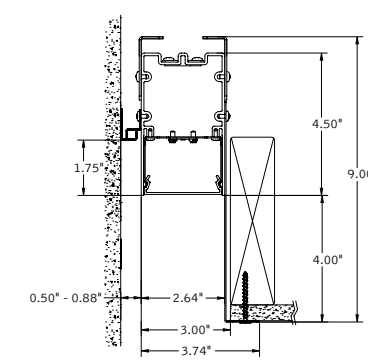
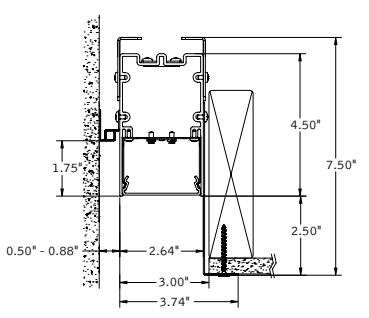
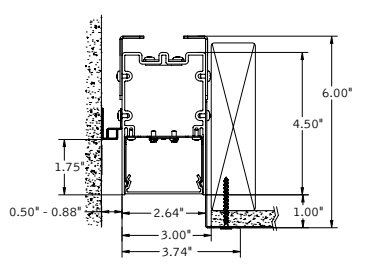
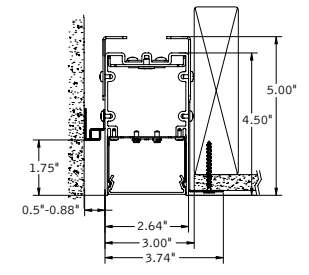



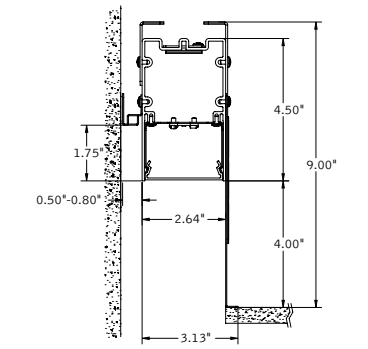
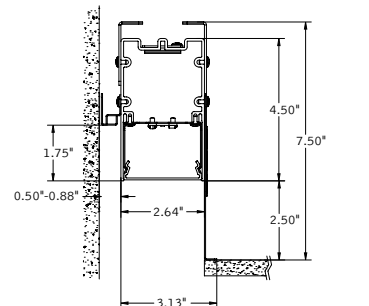
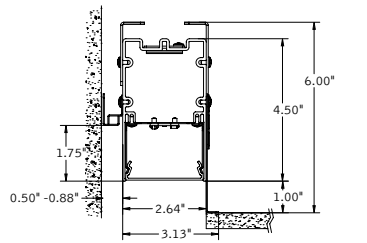
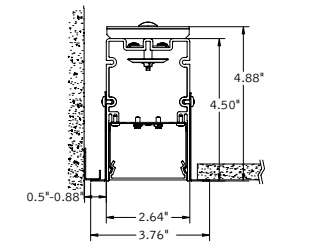

TRIM FLANGE (TF)	TRIMLESS DRYWALL (XF)
------------------	-----------------------



Focal Point provides broad flexibility through compatibility with a wide range of indoor lighting control systems. A variety of sensors, nodes, controllers, and drivers can be specified to scale the system and meet the needs of each application across both wired and wireless networks.

Features such as daylight harvesting, occupancy sensing, dimming, and switching help save energy, reduce costs, and enhance occupant comfort. All Connected Solutions luminaires require a compatible building control system.

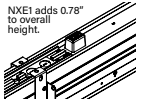
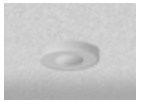
Controls systems supplied by others. For performance data and additional control system details, please visit the connected solutions manufacturers websites.

Connected Solution	Ordering Code	Model #	Protocol	Compatible Networks (Not all compatible networks may be listed.)	Description	Occupancy & Daylight	Communication to Luminaire	Drivers (Primary drivers are listed in bold. To specify a particular driver please consult factory.)	Driver Type
legrand® WATTSTOPPER®									
	WSPC	EN-ZBHA-CLM-DIM	ZigBee	Wattstopper PLUS	Node	Enabled†	Wireless	Advance by Signify	0-10V standard, consult factory for DALI
	WSPS	EN-CLM-PIR-DD-ZB	ZigBee	Wattstopper PLUS	Sensor	Integrated (remote)*	Wireless	Advance by Signify	0-10V standard, consult factory for DALI
COOPER Lighting Solutions									
	WLXP	OEM-WAA	WaveLinX Wireless	WaveLinX Pro Trellix	Sensor	Integrated (remote)*	Wireless (WaveLinX Pro Wireless Area Controller)	Advance by Signify	0-10V
Current®									
	NXE1	NXFM2-LV	NX	NX Distributed Intelligence	Controller	Enabled†	Wired	Optotronic by eldoLED	0-10V
LUTRON									
	LAW1	A-WN-D01-RF-WH	Clear Connect	Athena Wireless	Node	Enabled (remote)‡	Wireless	Advance by Signify	0-10V standard, consult factory for DALI
	LAWS	A-WN-D01-OCC-WH	Clear Connect	Athena Wireless	Sensor	Integrated (remote)*	Wireless	Advance by Signify	0-10V standard, consult factory for DALI
nLIGHT									
	NLT1	nEPS-60-IO	nLight	nLight	Controller	Enabled†	Wired	eldoLED ECOdrive, eldoLED SOLOdrive	0-10V

†Enabled: Luminaire supplied with a node/controller. Sensor to be provided by others.

*Integrated (remote): Luminaire supplied with a sensor to be installed in a remote location by others.

‡Enabled (remote): Luminaire supplied with a node/controller to be installed in a remote location by others.

SELECTING THE BEST OPTIC FOR EACH APPLICATION

8' W x 40' L x 9' H Corridor | 80/50/20 Reflectances | 0.9 Light Loss Factor

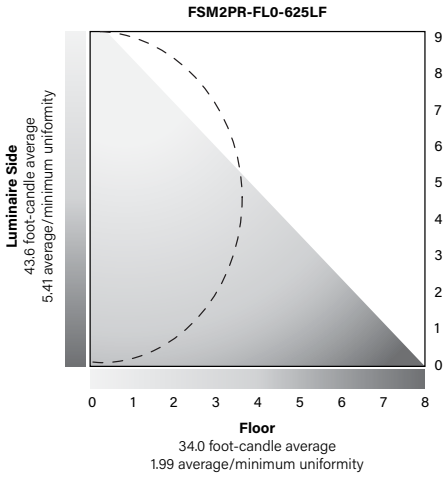

Standard Lens

The standard optic results in a Lambertian light distribution that provides uniform illumination. It is ideal to create a glowing transition between the walls and ceiling, adding dimension to the space.

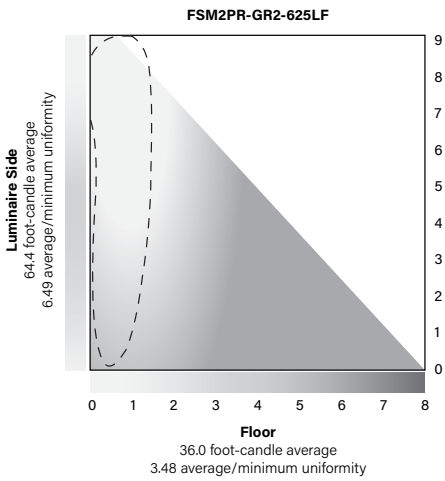
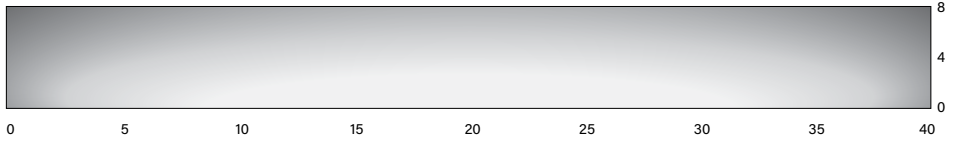

Grazer Lens

The grazer optic closely grazes walls, highlighting textures and architectural details. It is intended to provide even illumination and deliver maximum visual impact on the vertical surfaces.

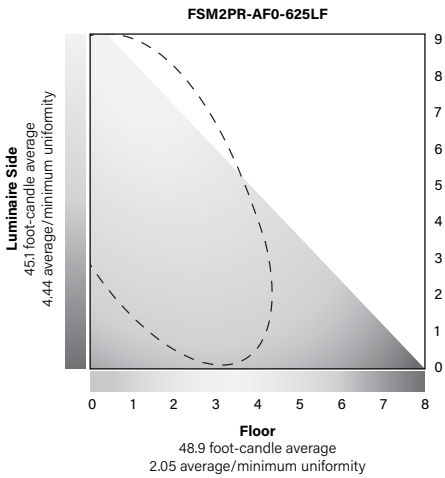
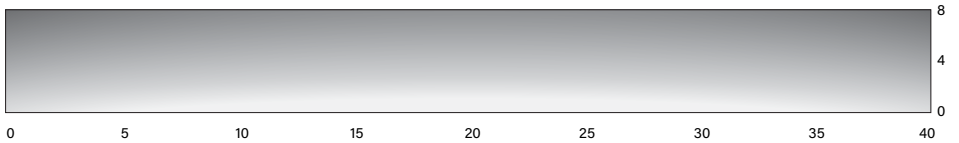

Asymmetric Room Fill Lens

The asymmetric room fill optic projects light into the space to evenly illuminate horizontal planes. It is ideal to light rooms and corridors from the perimeter, resulting in superior efficacy and uniformity on the floor.

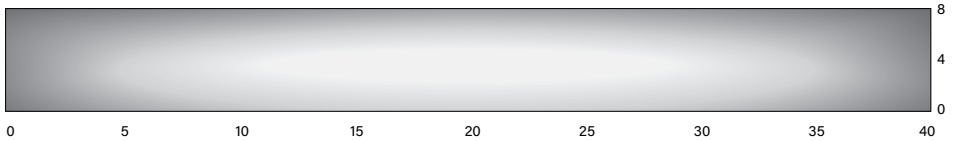

Wall-to-Wall Symmetry