

# Seem® 1 Louver

LED DIRECT WITH ID+ TECHNOLOGY

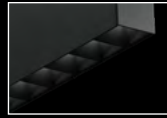

FOCAL POINT®



Black Specular Louver

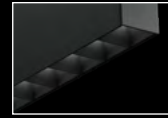

Black Matte Louver



Clear Diffuse Louver



Clear Specular Louver



The Naturals collection - Walnut shown



Matte White Louver



Solid Faceplate + Louver



Recessed Companion

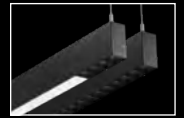

Direct/Indirect Companions

## DIMENSIONAL DATA

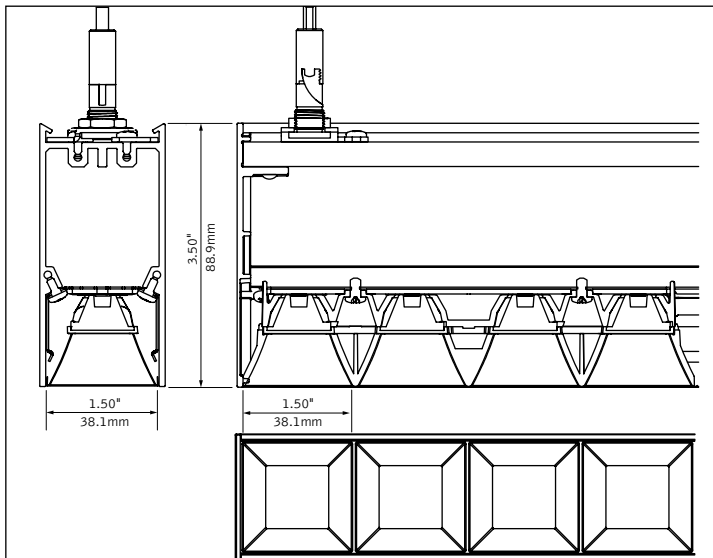

### Mounting Information

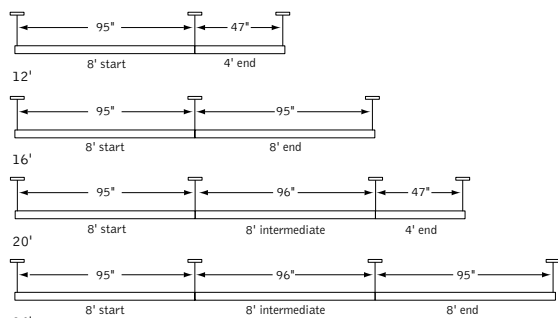

Consult factory for additional row length information.

## FEATURES

Nominal 1.5" narrow extruded aluminum linear direct LED illumination with louver and high-performance optics.

Frosted acrylic lenses provide uninterrupted illumination, without pixels or shadows.

Deeply regressed louver cells provide 60° cut-off from light source to promote visual comfort.

Diversity of louver finishes to tailor how the light is perceived and experienced, from nearly invisible light sources with a striking transition to warmly illuminated louver cells with a smooth transition.

Choice of output levels and light distributions support multiple applications, from highly focused task lighting to ambient lighting.

Individual units and continuous runs in 1" lensed or faceplate increments, and 6" louvered increments.

Highly configurable system enables self-service creation of customized products with standard lead times.

Available with The Naturals, a series of finishes that exude biophilic beauty.

fixture:

project:

**STANDARD LOUVER CONFIGURATION EXAMPLES**

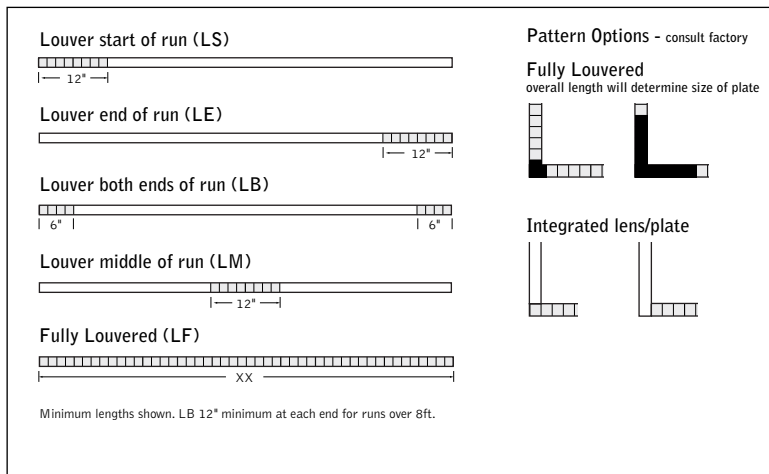

**SPECIFICATIONS**

**LED System**

Proprietary linear LED module incorporates premium LEDs on a robust platform to achieve excellent thermal management. LEDs are placed to promote a uniform appearance. Available in 2700K, 3000K, 3500K or 4000K with both 80 and 90 CRI options. LED modules and drivers are replaceable from below. Color accuracy <3 SDCM.

**Construction**

One piece extruded aluminum housing. Cast aluminum end caps. 8' unit weight: 15lbs.

**Optic**

60-degree cut-off to louvered light source and its image. Lensed reflectors fabricated of 24 Ga. steel finished in High Reflectance White powder coat. Extruded acrylic lens .085" thick with frosted finish, up to 8' continuous.

**Electrical**

Luminaires are pre-wired with factory installed branch circuit wiring and over-molded quick connects. Standard 120-277V constant current driver includes 0-10V analog dimming. Power factor > .9.

**Emergency**

Emergency output - 10 watts for 90 minutes. Louvered maximum mounting height (LC, SC) = 26.4ft, lensed maximum mounting height (BC, FC) = 18ft.

**Labels**

UL and cUL listed. Suitable for Dry or Damp Locations, indoor use only.

**Finish**

Polyester powder coat applied over a multi-stage pre-treatment. Canopy and cord white as standard. The Naturals: 100% low VOC vinyl.

**Lumen Maintenance**

Linear Source  
 Reported: L70 at >61,000 hours      Calculated: L70 at 470,000 hours  
                   L90 at >61,000 hours      L90 at 115,000 hours

Louvered Sources  
 Reported: L70 at >54,000 hours      Calculated: L70 at 138,000 hours  
                   L90 at 43,000 hours      L90 at 43,000 hours

Derived from EPA TM-21 calculator. Based on typical conditions, consult factory for additional data.

**Reliability**

At Focal Point, our products are designed to stand the test of time. Each luminaire is engineered using superior components, manufactured with the utmost care and rigorously tested. Contact us for reliability data.

**Warranty**

LED system rated for operation in ambient environments up to 25°C. 5-year limited warranty.

**DISTRIBUTIONS**

	NFL	FL1	FL2	WFL	LMC
Beam Spread	20°	29°	43°	67°	68°
Spacing Criteria	0.36	0.50	0.70	0.98	1.18

**PERFORMANCE CHARTS**

See page 4

Focal Point LLC reserves the right to change specifications for product improvement without notification.

**STANDARD CONFIGURATION ORDERING**

	Luminaire Series	FSM1CS
	Seem 1 with Louver	FSM1CS
	<b>Shielding</b>	
	Batwing lens + Louver	BC
	Flush lens + Louver	FC
	Solid faceplate + Louver	SC
	Louver only	LC
	<b>Louver Configuration</b> (Specify total length of louver in inches for run length. Example: 36" of Louver at start of run = LS36)	
	Louver start or end of run (6" increments, 12" min.)	LS_ or LE_
	Louver both ends of run (12" increments, split equally) (Runs over 8ft must contain min. 24" of louver)	LB_
	Louver middle of run (12" increments) (12" Louver increments. Min 24" of lens or faceplate, split equally.)	LM_
	Fully Louvered (LC shielding only, length matches run length)	LF
	<b>Lumen Output</b>	
LUMEN OUTPUT OPTIONS (specify value for each distribution. Example: 625DN-1000DL)	250 Lumens per foot (Consult factory for available options)	250
	375 Lumens per foot	375
	500 Lumens per foot	500
	625 Lumens per foot	625
	750 Lumens per foot	750
	875 Lumens per foot	875
	1000 Lumens per foot	1000
	<b>Direct Lensed Distribution</b> _____DN	
	(625 lumens max. Use "0DN" for SC & LC options.) (Consult Factory for LH1 & D11 with BC & FC for 375 & 500 lm/ft.)	
	<b>Direct Louvered Distribution</b> _____DL	
	<b>Color Temperature</b>	
	2700K, 80CRI or 90 CRI	27K or 927K
	3000K, 80CRI or 90 CRI	30K or 930K
	3500K, 80CRI or 90 CRI	35K or 935K
	4000K, 80CRI or 90 CRI	40K or 940K
	<b>Circuit</b>	
	Single Circuit	1C
	Dual Circuit (FC & BC shielding only)	2C
	<b>Voltage</b>	
	120/277 UNV Volt	UNV
	347 Volt (LD1 driver only)	347
	<b>Control System &amp; Dimming Level</b>	
	0-10V - 10% Dimming	LD1
	0-10V - 1% Dimming	L11
	Lutron Hi-Lume EcoSystem (LDE1) - 1% Dimming	LH1
	DALI 1% Dimming	D11
	<b>Mounting</b>	
	24" Cable Suspension	C24_
	48" Cable Suspension	C48_
	96" Cable Suspension	C96_
	(Specify canopy color, see finishes page for options. Example: White = C24WH.) (Specify one of the following in place of "C" J - for 2" canopies at non-lead locations. CS - for sloped ceiling applications.)	
	<b>Surface Mount</b>	SM
	<b>Distribution</b>	
	Narrow Flood	NFL
	Flood 1	FL1
	Flood 2	FL2
	Wide Flood	WFL
	Louvered Mixing Chamber	LMC
	<b>Factory Options</b>	
	Black Cord	BKCD
	Emergency Circuit	_EC
	Emergency Battery Pack (4 min. length with LC shielding. Consult factory for integrated options.)	_EM
	<b>Louder Finish</b>	
	Matte Black	BK
	Black Specular	BS
	Clear Diffuse	CD
	Clear Specular	CS
	Matte White	WH
	<b>Housing &amp; Faceplate Finish</b> (See finishes page for The Naturals options)	
	Matte Black	BK
	Titanium Silver	TS
	Matte White	WH
	<b>Luminaire Length</b>	
	Total luminaire/row length (12" increments; 6" increments for LF; 4" minimum run length.)	_ft_in

fixture:

project:

**TAILORED CONFIGURATION ORDERING**

**TAILORED LOUVER CONFIGURATION EXAMPLES**

**Alternating louver & lens/faceplate starting with louver (ACS)**

**examples:**

12ft run = 24" louver sections, 36" lens/faceplate sections (ACS24-3S, 12ft run)

10ft run = 24" louver sections, 24" lens/faceplate sections (ACS24-3S, 10ft run)

12ft run = 30" louver sections, 27" lens/faceplate sections (ACS30-3S, 12ft run)

10ft run = 18" louver sections, 16" lens/faceplate sections (ACS18-4S, 10ft run)

**Alternating louver & lens/faceplate starting with lens/faceplate (AFS)**

**examples:**

12ft run = 24" louver sections, 32" lens/faceplate sections (AFS24-2S, 12ft run)

10ft run = 24" louver sections, 24" lens/faceplate sections (AFS24-2S, 10ft run)

12ft run = 30" louver sections, 28" lens/faceplate sections (AFS30-2S, 12ft run)

10ft run = 18" louver sections, 16.5" lens/faceplate sections (AFS18-3S, 10ft run)

**SPECIFICATIONS**

See page 2

**DISTRIBUTIONS**

	NFL	FL1	FL2	WFL	LMC
Beam Spread	20°	29°	43°	67°	68°
Spacing Criteria	0.36	0.50	0.70	0.98	1.18

**PERFORMANCE CHARTS**

See page 4

**Luminaire Series**

Seem 1 with louver FSM1CS

**FSM1CS**

**Shielding**

Batwing lens + Louver BC  
 Flush lens + Louver FC  
 Solid faceplate + Louver SC

**Louver Configuration**

(Specify length of each louver segment in 6" increments, 12" minimum, and the total number of louver segments in the run.  
 Example: 24" louver segments, 4 segments total = ACS24-4S  
 \*Consult factory for 6" segment availability.)

**Alternating louver & lens/faceplate starting with louver** (Min. 3 segments per run.) ACS\_-\_S

**Alternating louver & lens/faceplate starting with lens/faceplate** (Min. 2 segments per run.) AFS\_-\_S

**Lumen Output**

(Consult factory for available lumen outputs based on specified Louver Configuration)

250 Lumens per foot	250
375 Lumens per foot	375
500 Lumens per foot	500
625 Lumens per foot	625
750 Lumens per foot	750
875 Lumens per foot	875
1000 Lumens per foot	1000

**LUMEN OUTPUT OPTIONS**  
 (Specify value for each distribution. Example: 625DN-1000DL)

**Direct Lensed Distribution** \_\_\_\_\_DN

(625 lumens max. Use "0DN" for SC option.)  
 (Consult Factory for LH1 & D11 with BC & FC for 375 & 500 lm/ft.)

**Direct Louvered Distribution** \_\_\_\_\_DL

**Color Temperature**

2700K, 80CRI or 90 CRI	27K or 927K
3000K, 80CRI or 90 CRI	30K or 930K
3500K, 80CRI or 90 CRI	35K or 935K
4000K, 80CRI or 90 CRI	40K or 940K

**Circuit**

Single Circuit 1C  
 Dual Circuit (FC & BC shielding only) 2C

**Voltage**

120/277 UNV Volt UNV  
 347 Volt (LD1 driver only) 347

**Control System & Dimming Level**

0-10V - 10% Dimming	LD1
0-10V - 1% Dimming	L11
Lutron Hi-Lume EcoSystem (LDE1) - 1% Dimming	LH1
DALI 1% Dimming	D11

**Mounting**

24" Cable Suspension C24\_\_\_\_  
 48" Cable Suspension C48\_\_\_\_  
 96" Cable Suspension C96\_\_\_\_

(Specify canopy color, see finishes page for options.  
 Example: White = C24WH.)  
 (Specify one of the following in place of "C"  
 J - for 2" canopies at non-feed locations.)  
 CS - for sloped ceiling applications.)

Surface Mount SM

**Distribution**

Narrow Flood NFL  
 Flood 1 FL1  
 Flood 2 FL2  
 Wide Flood WFL  
 Louvered Mixing Chamber LMC

**Factory Options**

Black Cord BKCD  
 Emergency Circuit \_EC  
 Emergency Battery Pack \_EM  
 (Consult factory for available options.)

**Louver Finish**

Matte Black BK  
 Black Specular BS  
 Clear Diffuse CD  
 Clear Specular CS  
 Matte White WH

**Housing & Faceplate Finish**

(See finishes page for The Naturals options)

Matte Black BK  
 Titanium Silver TS  
 Matte White WH

**Luminaire Length**

Total luminaire/row length \_\_\_\_\_ft\_in  
 (12" increments. 4" minimum run length.)

## 4' PERFORMANCE CHART - LENSED DISTRIBUTIONS

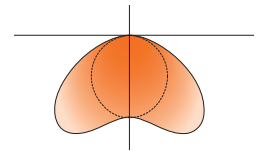
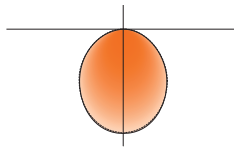

Lumens per Foot	Delivered Lumens	Tested System Watts	4' Flush Lens LPW	Tested System Watts	4' Batwing Lens LPW
250LF	1000	9	110	9	115
375LF	1500	13	119	12	125
500LF	2000	16	121	16	128
625LF	2500	20	122	19	129

Based on 3500K, 4' length. Lumen output may vary +/- 5%. Actual wattage may vary +/- 5%.

Distribution	Lumens per Foot	Tested System Watts	LPW
WFL	250	11.0	92
	375	14.7	101
	500	19.3	106
	625	24.3	105
	750	28.3	107
	875	32.6	107
	1000	37.0	108

Based on 4' luminaire, 3500K, 80 CRI, Matte Black baffle. Lumen output may vary +/- 5%. Actual wattage may vary +/- 5%.

## PERFORMANCE CURVES

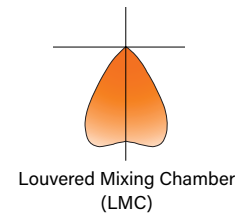
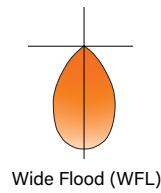
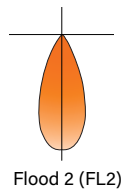
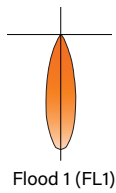
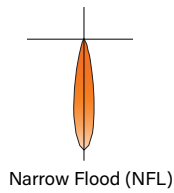

## SEEM 1 LOUVER LUMEN MULTIPLIER TABLE

### Lens Color Temperature & CRI

Color Temperature	Multiplier
2700K, 80+ CRI [27K]	0.96
2700K, 90+ CRI [927K]	0.79
3000K, 80+ CRI [30K]	1.00
3000K, 90+ CRI [930K]	0.82
3500K, 80+ CRI [35K]	1.00
3500K, 90+ CRI [935K]	0.84
4000K, 80+ CRI [40K]	1.01
4000K, 90+ CRI [940K]	0.86

### Louver Color Temperature & CRI

Color Temperature	Multiplier
2700K, 80+ CRI [27K]	0.95
2700K, 90+ CRI [927K]	0.80
3000K, 80+ CRI [30K]	0.97
3000K, 90+ CRI [930K]	0.83
3500K, 80+ CRI [35K]	1.00
3500K, 90+ CRI [935K]	0.85
4000K, 80+ CRI [40K]	1.03
4000K, 90+ CRI [940K]	0.87

### Louver Distribution

Distribution	Multiplier
Narrow Flood [NFL]	1.34
Flood 1 [FL1]	1.14
Flood 2 [FL2]	1.21
Wide Flood [WFL]	1.00
Louvered Mixing Chamber [LMC]	0.97

### Louver Finish

Color	Multiplier
Matte Black [BK]	1.00
Black Specular [BS]	1.00
Clear Diffuse [CD]	1.07
Clear Specular [CS]	1.10
Matte White [WH]	1.11

## How To Use Lumen Multipliers

**Formula:** (Lumen Output Value) x (Color Temperature & CRI) x (Distribution) x (Finish)

**Louver Example:** FSM1CBS-1000DL-930K-NFL-BS  
 $(1000) \times (0.83) \times (1.34) \times (1.00) \approx 1112.2 \text{ lm}$  (estimated delivered lumens)

## SEEM 1 LOUVER APPLICATION EXAMPLE - FULLY LOUVERED

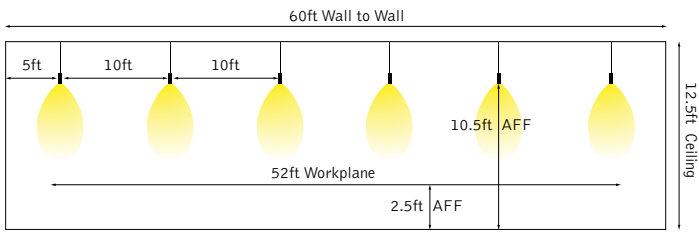

**Average Illuminance = 38 fc**

**Lighting Power Density (LPD) = 0.38**

Seem 1 Louver with fully louvered direct illumination is a powerful and efficacious solution for open working environments. Workplanes benefit from 32 footcandles or more and superior uniformity with a lighting power density of less than 0.38 while maintaining luminaire on-center spacing of 8 feet or greater.

Workplane Illuminance

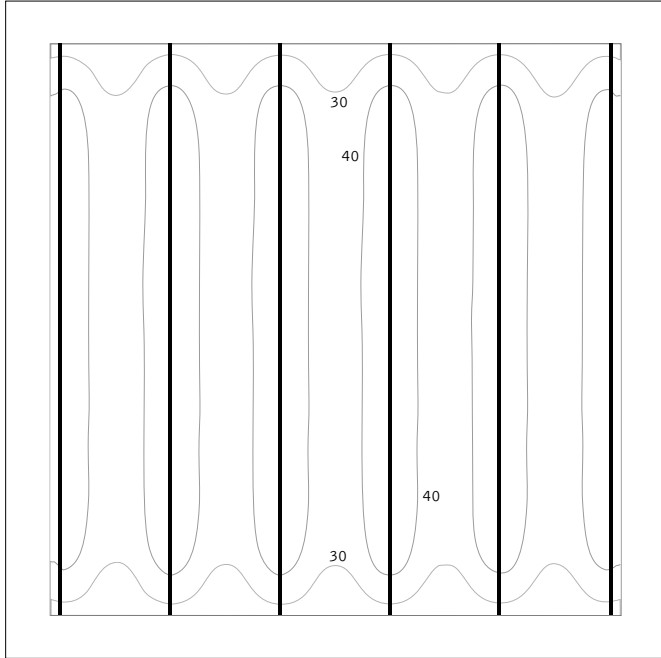

### Calculation Details

Room Area:	60ft x 60ft
Calculation Area:	52ft x 52ft
Ceiling Height:	12.5ft
Luminaire Height:	10.5ft AFF
Luminaire Spacing:	10ft OCS
Workplane Height:	2.5ft AFF
Reflectances:	80/50/20
Light Loss Factor:	0.9

### Luminaire Details

Shielding:	Fully Louvered, Wide Flood
Lumens per foot:	375 Direct
Louver finish:	Matte Black

Ceiling Height	Installation		Lumens/ft	Louver Distribution	LPD (Watts/ft <sup>2</sup> )	Workplane	
	AFF	On-center Spacing				Average Footcandles	Uniformity (avg. to min.)
11ft	9ft	8ft	250LF	WFL	0.34	33.1	2.00
				LMC		32.0	1.95
12.5ft	10.5ft	10ft	375LF	WFL	0.38	38.1	1.98
				LMC		36.8	1.96

# Finishes



## STANDARD FINISHES



WHITE WH BLACK BK TITANIUM SILVER TS

## THE NATURALS (25% SCALE)

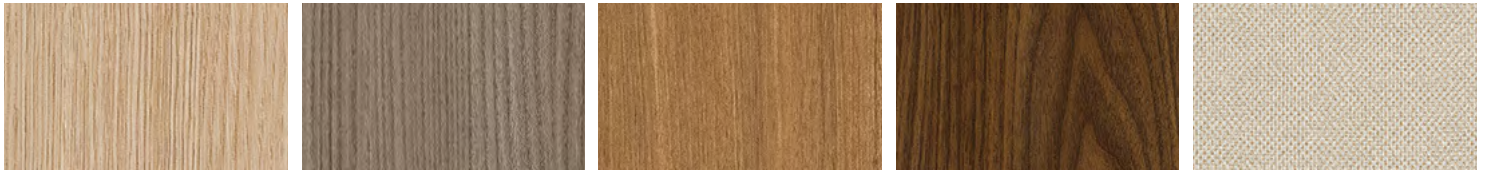

LIGHT OAK LOK GRAY ELM GRE CHESTNUT CHT WALNUT WLT WOVEN LINEN WLN