

# id<sup>®</sup> 4.5" x 4.5"

LED - REMOTE PHOSPHOR DOWNLIGHT

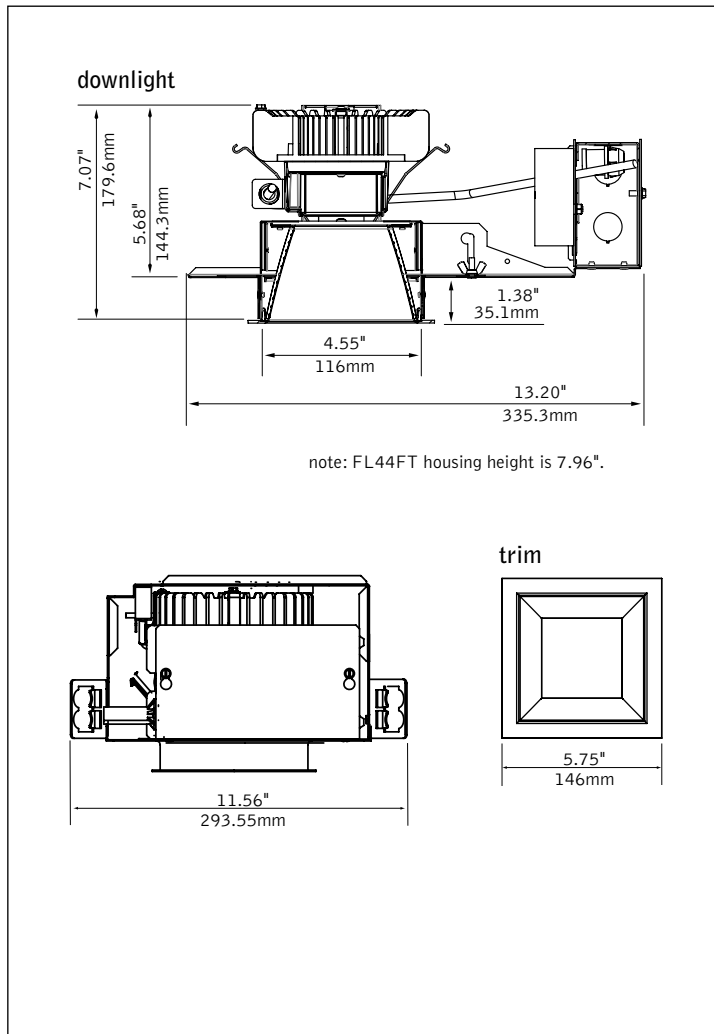

## DIMENSIONAL DATA



## FEATURES

LED module features remote phosphor technology enabling a high system efficacy and minimum 80 CRI.

Intelligent driver delivers specified lumen output regardless of color temperature.

Flicker-free 0-10V analog dimming capability standard.

Low profile housing.

Housing design allows die-cast trim flange to rotate to align with architecture and adjacent luminaires, a fixed option is also available.

Clear Diffuse reflector cone features superior brightness control and 55 degree cutoff to light source and its image.

## PERFORMANCE

PRODUCT OVERVIEW	
Lumen Output:	885-1671lm
Wattage:	16-29W
LPW:	58-59
SDCM:	3
Lumen Maintenance:	L70 @ 50,000hrs

Clear Diffuse Reflector  
3000k, 1100 Lumen LED  
Module

**Delivered Lumens: 949lm**

**Total System Watts: 16W**

Photometric performance is measured in accordance with IESNA LM-79.  
Visit [focalpointlights.com](http://focalpointlights.com) for complete photometric data.

fixture:

project:

## HOUSING TYPES

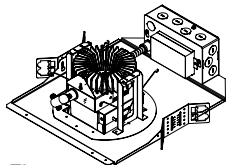

FL44

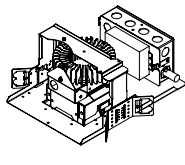

FL44F

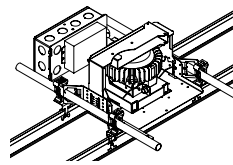

FL44FT

## HOUSING SPECIFICATIONS

### LED System

Powered by Philips' Fortimo™ LED DLM, Advance Xitanium LED driver and communication cable. Aluminum heat sink provides appropriate thermal management.

### LED Module

Philips' Fortimo™ LED DLM features patented remote phosphor technology for superior efficacy and color consistency. Module may be specified in 3000K or 3500K, CRI>80.

### Construction

Thermally protected housing for new construction applications. Insulation to be kept 3" away from housing. Butterfly brackets allow mounting to ½ emt. Order bar hangers as an accessory. Die-cast aluminum heat sink designed for maximum thermal dissipation. Die-formed housing and integral junction box with (7) 1/2" pry outs. Accommodates ceiling thicknesses up to 1" (FL44) or 2" (FL44F/FL44FT). FL44FT housing includes mounting clips to integrate between 6" on center tees. Fixture will not exceed 5 lb. 18" O.C. fixture to wall and 36" O.C. fixture to fixture spacing required.

### Electrical

Advance Xitanium multi-volt 120V-277V constant current driver includes standard 0-10V analog dimming. Power factor >.9 typical, 50/60Hz., 200-700mA. "Thermal Guard" offers protection from overheating in abnormal conditions; driver will dim DLM if necessary. Voltage specific thermal protectors included standard.

### Dimming

0-10V DC low voltage dimming capability is included with the standard Advance Xitanium driver. Dimming range is to 10% light output, some dimmers may require high and/or low end trim adjustment for proper function.

### Labels

UL and cUL listed. Suitable for Dry or Damp Locations, indoor use only. Lensed trims suitable for Wet Location.

### Lumen Maintenance

L70 at 50,000 hours

### Warranty

LED System rated for operation in ambient environments up to 25°C. 5 year limited warranty.

## TRIM SPECIFICATIONS

### Aesthetics

Die-formed aluminum reflector ensures glare free optics. Reflector attaches to die-cast, seamless flange and may be removed for field painting. Torsion springs pull trim tight to the ceiling with no visible fasteners within the trim. Trim position rotates up to 110° for fine adjustment (FL44).

### Optics

55-degree cut-off to light source and its image.

## PERFORMANCE CHART

Nominal Output	Color Temp	System Watts	Delivered Lumens	LPW
11LED	3000K	16	963	58.9
15LED	3000K	21	1233	58.7
20LED	3000K	29	1671	58.3

\*Based on Clear Diffuse reflector cone. Rated Output is the same for all color temps. Wattage reduction with other color temps. Lumen output may vary +/- 5%. Actual wattage may vary +/- 5%.

## HOUSING ORDERING

<b>Housing Series</b>	_____
ID LED Square with rotating trim alignment feature	FL44
ID LED Square with fixed aperture	FL44F
ID LED Square for mounting between 6" on center tees <small>(Not recommended with single-tile spacing between fixtures due to ceiling tile interference)</small>	FL44FT
<b>Trim Type</b>	_____
Square Overlap	SO
Square Flush <small>(FL44 &amp; FL44F only)</small>	SF
<b>Nominal Output</b>	_____
1100 Lumen LED Module	11LED
1500 Lumen LED Module	15LED
2000 Lumen LED Module	20LED
<b>Color Temperature</b>	_____
3000K	30K
3500K	35K
<b>Voltage</b>	_____
120V	120
277V	277
<b>Driver</b>	_____
0-10V Dimming	LD1
Lutron A-Series - 1% EcoSystem Digital <small>(consult factory for 3-wire control)</small>	L3D
<b>Housing Type</b>	<b>T</b>
Thermally Protected, Non-IC	T
<b>Factory Options</b>	_____
Bar Hangers <small>(FL44, FL44F only)</small>	BH
Chicago Plenum	CP
Emergency Battery <small>Consult EM specific cutsheet</small>	

## TRIM ORDERING

<b>Aperture</b>	<b>L44</b>
4.5" Square Reflector	L44
<b>Trim Type</b>	<b>SQ</b>
Square <small>(Compatible with SO and SF housings)</small>	SQ
<b>Optic</b>	_____
Downlight	DN
Regress MicroGlow Lens <small>(Wet location)</small>	RLMG
<b>Color</b>	_____
Clear Diffuse	CD
Warm Diffuse	WD
Silver Talc Diffuse	TD
<b>Flange Finish</b>	_____
White	WH
Black	BK
Titanium Silver	TS
Aluminum Raw	AL

A complete unit consists of two line items, housing and trim  
Example: FL44-SO-15LED-30K-120-LD1-T | L44-SQ-DN-CD-WH



# id<sup>®</sup> 4.5" x 4.5"

LED DOWNLIGHT

## FL44-SO-11LED-L30-120-LD1-T / L44-SQ-DN-CD

Filename: FL44DNCD11LEDL30.IES  
Test #: 101418870CHI-017

Lumens: 949lm  
System Watts: 16W  
LPW: 58

### CANDLEPOWER DISTRIBUTION

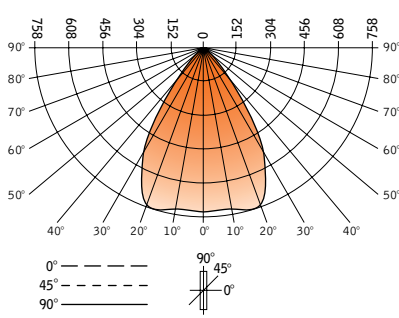

Vertical Angle	Horizontal Angle				
	0°	22.5°	45°	67.5°	90°
0°	741	741	741	741	741
5°	734	736	738	738	743
15°	749	742	734	747	758
25°	665	668	706	671	666
35°	363	386	432	386	355
45°	81	104	132	102	76
55°	26	26	20	24	23
65°	8	8	7	7	7
75°	2	2	2	2	2
85°	0	0	0	0	0
90°	0	0	0	0	0

### LUMEN SUMMARY

Zone	Lumens	% Fixture
0-30°	585.9	61.8
0-40°	827.5	87.2
0-60°	937.8	98.9
0-90°	948.6	100.0
<b>Total Luminaire</b> 0-180°	<b>948.6</b>	<b>100.0</b>

Footcandle results based on AGI32; Reflectances=0/0/0; LLF=1

Go to [www.focalpointlights.com](http://www.focalpointlights.com) for additional photometric data.

# id<sup>®</sup> 4.5" x 4.5"

LED DOWNLIGHT

## FL44-SO-15LED-L30-120-LD1-T / L44-SQ-DN-CD

Filename: FL44DNCD15LEDL30.IES  
Test #: 101418870CHI-018

Lumens: 1219lm  
System Watts: 21W  
LPW: 58

### CANDLEPOWER DISTRIBUTION

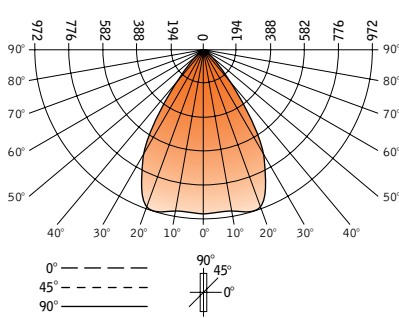

Vertical Angle	Horizontal Angle				
	0°	22.5°	45°	67.5°	90°
0°	940	940	940	940	940
5°	936	939	942	942	939
15°	954	947	938	956	972
25°	844	850	901	858	855
35°	456	491	551	498	464
45°	102	136	173	136	100
55°	33	32	25	30	29
65°	10	10	9	9	9
75°	3	3	3	3	2
85°	0	0	0	0	0
90°	0	0	0	0	0

### LUMEN SUMMARY

Zone	Lumens	% Fixture
0-30°	749.0	61.5
0-40°	1060	87.0
0-60°	1205	98.9
0-90°	1219	100.0
<b>Total Luminaire</b> 0-180°	<b>1219</b>	<b>100.0</b>

### FOOTCANDLE VALUES

0° aiming angle - horizontal surface

Distance from source	Beam Diameter	Center Beam (FC)
2'	2.7'	235.1
4'	5.5'	58.8
6'	8.2'	26.1
8'	9.9'	14.7
10'	12.4'	9.4

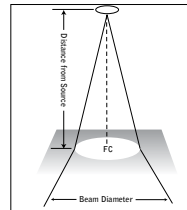

Footcandle results based on AGI32; Reflectances=0/0/0; LLF=1

Go to [www.focalpointlights.com](http://www.focalpointlights.com) for additional photometric data.

# id<sup>®</sup> 4.5" x 4.5"

LED DOWNLIGHT

## FL44-SO-20LED-L30-120-LD1-T / L44-SQ-DN-CD

Filename: FL44DNCD20LEDL30.IES  
Test #: 101418870CHI-019

Lumens: 1645lm  
System Watts: 29W  
LPW: 57

### CANDLEPOWER DISTRIBUTION

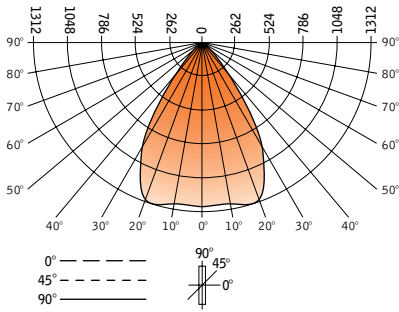

Vertical Angle	Horizontal Angle				
	0°	22.5°	45°	67.5°	90°
0°	1270	1270	1270	1270	1270
5°	1266	1270	1273	1273	1269
15°	1293	1282	1269	1292	1312
25°	1140	1154	1219	1160	1154
35°	620	672	747	671	625
45°	137	185	234	180	134
55°	44	43	34	39	39
65°	14	14	13	13	12
75°	4	4	4	4	4
85°	1	1	1	1	1
90°	0	0	0	0	0

### LUMEN SUMMARY

Zone	Lumens	% Fixture
0-30°	1012	61.5
0-40°	1432	87.1
0-60°	1626	98.9
0-90°	1645	100.0
<b>Total Luminaire 0-180°</b>	<b>1645</b>	<b>100.0</b>

### FOOTCANDLE VALUES

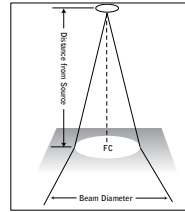

0° aiming angle - horizontal surface

Distance from source	Beam Diameter	Center Beam (FC)
2'	2.7'	317.6
4'	5.5'	79.4
6'	8.2'	35.3
8'	11.0'	19.9
10'	13.7'	12.7

Footcandle results based on AGI32; Reflectances=0/0/0; LLF=1

Go to [www.focalpointlights.com](http://www.focalpointlights.com) for additional photometric data.

# id<sup>®</sup> 4.5" x 4.5"

LED DOWNLIGHT

## FL44-SO-30LED-L30-120-LD1-T / L44-SQ-DN-CD

Filename: FL44DNCD30LEDL30.IES  
Test #: 101418870CHI-020

Lumens: 2412lm  
System Watts: 41W  
LPW: 59

### CANDLEPOWER DISTRIBUTION

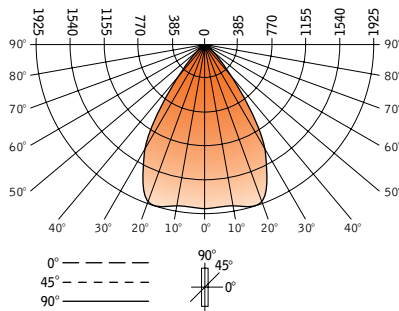

Vertical Angle	Horizontal Angle				
	0°	22.5°	45°	67.5°	90°
0°	1879	1879	1879	1879	1879
5°	1869	1872	1877	1876	1882
15°	1904	1888	1868	1899	1925
25°	1680	1696	1791	1703	1689
35°	903	986	1090	979	897
45°	200	272	344	265	193
55°	64	64	50	57	58
65°	20	20	19	18	18
75°	5	6	6	6	5
85°	1	2	2	2	1
90°	0	0	0	0	0

### LUMEN SUMMARY

Zone	Lumens	% Fixture
0-30°	1488	61.7
0-40°	2102	87.1
0-60°	2384	98.9
0-90°	2412	100.0
<b>Total Luminaire 0-180°</b>	<b>2412</b>	<b>100.0</b>

### FOOTCANDLE VALUES

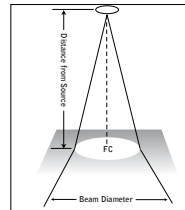

0° aiming angle - horizontal surface

Distance from source	Beam Diameter	Center Beam (FC)
2'	2.4'	291.5
4'	4.9'	72.9
6'	7.3'	32.4
8'	9.7'	18.2
10'	12.2'	11.7

Footcandle results based on AGI32; Reflectances=0/0/0; LLF=1

Go to [www.focalpointlights.com](http://www.focalpointlights.com) for additional photometric data.