

# focus™ 3



## features

High performance perimeter open wall washing system.

Luminaire alignment is maintained with continuous angle and splice brackets.

Focus™ 3 offers excellent vertical illumination without shielding.

## dimensional data

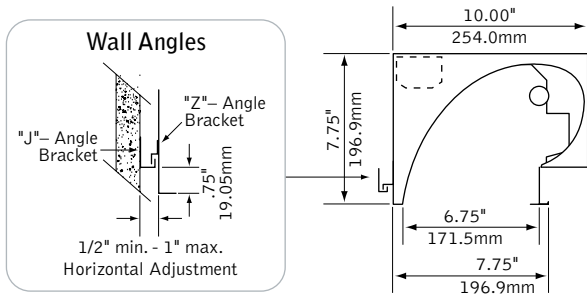

## lamping options

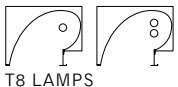

## performance

1-Lamp T8  
81% Efficiency  
1437cd @ 15°

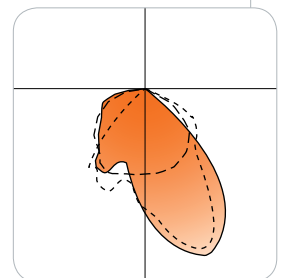

Visit [focalpointlights.com](http://focalpointlights.com) for complete photometric data.

fixture:  
project:

## details

### typical run layout

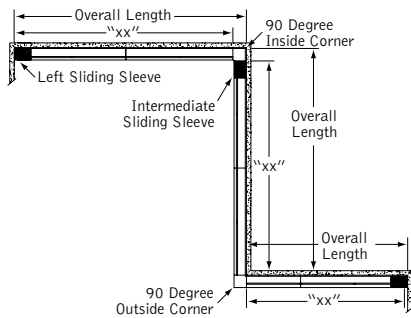

### sliding sleeves

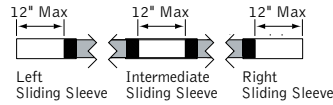

Fractional Dimensions up to 12" are taken up by the use of a sliding sleeve.

"J" and "Z" angle brackets must be cut to length in field.

Luminaires must be installed prior to ceiling.  
Start run from corner with any standard luminaire.  
Corner to corner runs end with an intermediate sleeve.

## specifications

### construction

- 20 Ga. steel housing.
  - 20 Ga. steel T-rail mates with ceiling.
  - 18 Ga. internal bulkheads join luminaires.
  - 18 Ga. galvanized steel splice brackets are provided to ensure precise luminaire alignment.
  - 20 Ga. steel continuous wall angles are provided to ensure horizontal alignment at wall.
- Luminaires are available up to 8' nominal lengths.

4' unit weight: 36 lbs  
8' unit weight: 49 lbs

### optic

CNC roll-formed semi-specular .024" aluminum front reflector with specular .024" aluminum back reflector.

### electrical

Electronic ballasts are thermally protected and have a Class "P" rating.  
Optional dimming ballasts available.  
Consult factory for dimming specifications and availability.  
UL and cUL listed.

### finish

Polyester powder coat applied over a 5-stage pre-treatment.  
Standard luminaire housing finished in Matte Satin White.

## ordering

luminaire series	FW3
Focus 3	FW3
shielding	NS
No Shielding, Open Optic	NS
lamping	
One Lamp T8	1T8
Two Lamp T8	2T8
One Lamp T5	1T5
Two Lamp T5	2T5
One Lamp T5HO	1T5HO
Two Lamp T5HO	2T5HO
circuit	
Single Circuit	1C
Dual Circuit (Two lamps only)	2C
voltage	
120 Volt	120
277 Volt	277
347 Volt	347
ballast	
Electronic Instant Start <20% THD	E
Electronic Program Start <10% THD	S
Electronic Dimming Ballast*	D
mounting	RC
Recessed	RC
factory options	
Air Return	AR
Emergency Circuit*	EC
Emergency Battery Pack*	EM
HLR/GLR Fuse	FU
Matte White Reflector	WR
Include 3000K Lamp	L830
Include 3500K Lamp	L835
Include 4100K Lamp	L841
Sliding Sleeve	SS
finish	WH
Matte Satin White	WH
luminaire length	
Designate length in feet	XX'
(Nominal lengths: 2', 3', 4', 5', 6', 7', 8')	
(All end caps are flat with no flange unless otherwise specified)	
corner options	
90-degree Inside Corner	FW3-IC90
90-degree Outside Corner	FW3-OC90

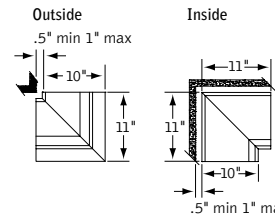

\* for more information see Reference section.

focus™ 3

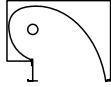

Filename: FW3NS1T8.IES  
 Catalog #: FW3-1T8-1C-120-E-RC-HW  
 Efficiency: 81%  
 Test #: 8761.0

CANDLEPOWER DISTRIBUTION

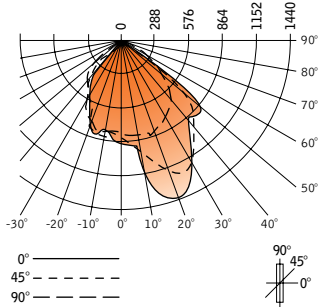

Vertical Angle	Horizontal Angle				Zonal Lumens
	0°	22.5°	45°	67.5°	
0°	1029	1029	1029	1029	1029
5°	1106	1100	1089	1074	1020
15°	1437	1393	1244	1087	996
25°	1334	1382	1399	1131	915
35°	775	883	1101	1125	772
45°	665	622	631	948	613
55°	344	417	497	584	420
65°	22	55	223	265	252
75°	7	12	16	94	97
85°	3	3	4	7	19
90°	0	0	0	0	0
95°	0	0	0	0	0
105°	0	0	0	0	0
115°	0	0	0	0	0
125°	0	0	0	0	0
135°	0	0	0	0	0
145°	0	0	0	0	0
155°	0	0	0	0	0
165°	0	0	0	0	0
175°	0	0	0	0	0
180°	0	0	0	0	0

LUMEN SUMMARY

Zone	Lumens	% Lamp	% Fixt
0°-30°	858	30.1	37.3
0°-40°	1394	48.9	60.5
0°-60°	2149	75.4	93.3
0°-90°	2303	80.8	100.0
<b>Total Luminaire</b>	<b>2303</b>	<b>81</b>	<b>100.0</b>

# focus standard run length

Continuous Runs consist of standard fixture lengths. Left and Right End Trims and Sliding Sleeves are determinate, according to specific field conditions. Consult factory for details.

Example: 32' run = three 8' fixtures and one 7' fixture with a sliding sleeve expandable to 32'.

run length (in feet)	standard fixture lengths required	lamp sizes	sliding sleeve	run length (in feet)	standard fixture lengths required	lamp sizes	sliding sleeve
4-5	4	4	1	34-35	8 8 8 6 4	4 4 4 4 4 4 4 3 3	1
5-6	5	5	1	35-36	8 8 8 8 3	4 4 4 4 4 4 4 4 3	1
6-7	6	3 3	1	36-37	8 8 8 8 4	4 4 4 4 4 4 4 4 4	1
7-8	7	4 3	1	37-38	8 8 8 6 7	4 4 4 4 4 4 4 3 3 3	1
8-9	8	4 4	1	38-39	8 8 8 8 6	4 4 4 4 4 4 4 4 3 3	1
9-10	6 3	3 3 3	1	39-40	8 8 8 8 7	4 4 4 4 4 4 4 4 4 3	1
10-11	6 4	3 3 4	1	40-41	8 8 8 8 8	4 4 4 4 4 4 4 4 4 4	1
11-12	8 3	4 4 3	1	41-42	8 8 8 8 6 3	4 4 4 4 4 4 4 4 3 3 3	1
12-13	8 4	4 4 4	1	42-43	8 8 8 8 6 4	4 4 4 4 4 4 4 4 4 3 3	1
13-14	7 6	4 3 3 3	1	43-44	8 8 8 8 8 3	4 4 4 4 4 4 4 4 4 4 3	1
14-15	8 6	4 4 3 3	1	44-45	8 8 8 8 8 4	4 4 4 4 4 4 4 4 4 4 4 4	1
15-16	8 7	4 4 4 3	1	45-46	8 8 8 8 7 6	4 4 4 4 4 4 4 4 4 3 3 3	1
16-17	8 8	4 4 4 4	1	46-47	8 8 8 8 8 6	4 4 4 4 4 4 4 4 4 4 3 3	1
17-18	8 6 3	4 4 3 3 3	1	47-48	8 8 8 8 8 7	4 4 4 4 4 4 4 4 4 4 4 3	1
18-19	8 6 4	4 4 4 3 3	1	48-49	8 8 8 8 8 8	4 4 4 4 4 4 4 4 4 4 4 4 4	1
19-20	8 8 3	4 4 4 4 3	1	49-50	8 8 8 8 8 6 3	4 4 4 4 4 4 4 4 4 4 3 3 3	1
20-21	8 8 4	4 4 4 4 4	1	50-51	8 8 8 8 8 7 3	4 4 4 4 4 4 4 4 4 4 4 3 3	1
21-22	8 7 6	4 4 4 3 3 3	1	51-52	8 8 8 8 8 8 3	4 4 4 4 4 4 4 4 4 4 4 4 3	1
22-23	8 8 6	4 4 4 4 3 3	1				
23-24	8 8 7	4 4 4 4 4 3	1				
24-25	8 8 8	4 4 4 4 4 4	1				
25-26	8 8 6 3	4 4 4 4 3 3 3	1				
26-27	8 8 6 4	4 4 4 4 4 3 3	1				
27-28	8 8 8 3	4 4 4 4 4 4 3	1				
28-29	8 8 8 4	4 4 4 4 4 4 4	1				
29-30	8 8 7 6	4 4 4 4 4 3 3 3	1				
30-31	8 8 8 6	4 4 4 4 4 4 3 3	1				
31-32	8 8 8 7	4 4 4 4 4 4 4 3	1				
32-33	8 8 8 8	4 4 4 4 4 4 4 4 4	1				
33-34	8 8 8 6 3	4 4 4 4 4 4 3 3 3	1				