

wall mount
twelve[™]

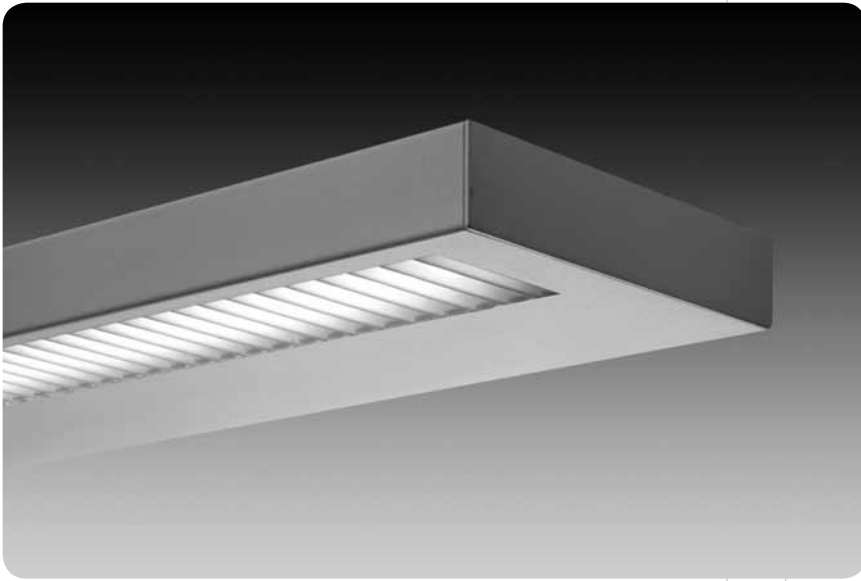

features

Low profile wall mount indirect with parallel blade baffle.

Parallel blade baffle with acrylic lens diffuser provides comfortable downlight shielding.

Sleek rectilinear housing only 1.4" high.

Hidden mounting bracket creates the appearance of a floating luminaire.

shielding options



solid (indirect)

companion luminaire



linear

dimensional data

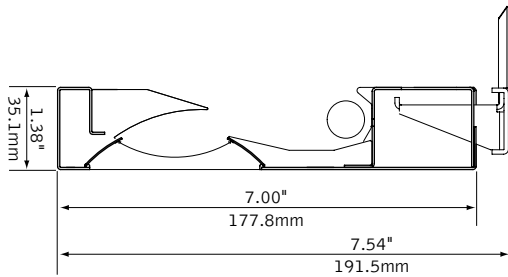

lamping options



T5/T5H0 LAMPS

fixture information

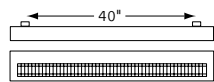

4' (46.5" overall length)

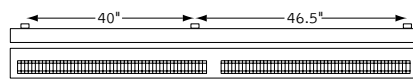

8' (93" overall length)

performance

1-Lamp T5H0
68% Efficiency
2431 cd @ 135°

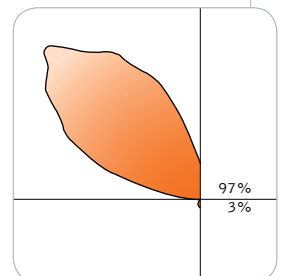

Visit focalpointlights.com for complete photometric data.

fixture:

project:

mounting information

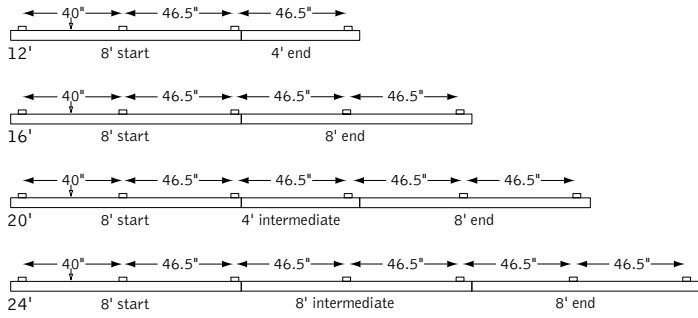

†Power feed location is 20" from left mounting bracket.

Consult factory for additional row length information.

specifications

construction

One-piece 20 Ga. steel housing.
 14 Ga. steel end caps mechanically attach flush to housing with concealed fasteners.
 For row installation, internal brackets form hairline joint.
 Standard lengths are available in 4' and 8'.
 All luminaires are provided with mounting brackets.

4' unit weight: 20 lbs.
 8' unit weight: 38 lbs.

optic

Reflector fabricated of low iridescent, semi specular premium grade aluminum.
 Parallel Blade baffle: 24 Ga. steel, .5"H x 2.8"W x .56" frequency.
 Baffle blade finished to match housing and backed with an acrylic lens diffuser.

electrical

Luminaires are pre-wired with factory installed branch circuit wiring and over-molded quick connects.
 Electronic ballasts are thermally protected and have a Class "P" rating.
 Optional dimming ballasts available.
 UL and cUL listed.

finish

Polyester powder coat applied over a 5-stage pre-treatment.
 Mounting brackets, rail and J-box plate finished in Matte Satin White.

ordering

fixture series	FTWW	<u>FTWW</u>
Twelve	FTWW	
shielding		<u> </u>
Parallel Blade Baffle	PB	
Solid, no lens, 100% indirect	SD	
lamping		<u> </u>
1 Lamp T5	1T5	
1 Lamp T5HO	1T5HO	
circuit		<u> 1C </u>
Single Circuit	1C	
voltage		<u> </u>
120 Volt	120	
277 Volt	277	
347 Volt	347	
ballast		<u> </u>
Electronic Program Start <10% THD	S	
Electronic Dimming Ballast*	D	
mounting		<u> WM </u>
Wall Mount	WM	
factory options		<u> </u>
Emergency Circuit*	EC	
Emergency Battery Pack*	EM	
HLR/GLR Fuse	FU	
Include 3000K Lamp*	L830	
Include 3500K Lamp*	L835	
Include 4100K Lamp*	L841	
(factory installed lamps recommended)		
finish		<u> </u>
Matte Satin White	WH	
Titanium Silver (louver painted to match housing)	TS	
fixture run length		<u> </u>
	4'	4'
	8'	8'
	12' (8'+4')	12'
	16' (8'+8')	16'
	20' (8'+4'+8')	20'
	24' (8'+8'+8')	24'
(individual units may not be field modified for continuous row mount)		

* for more information see Reference section.

wall mount
twelve™



Filename: FTWWPB1T5H.IES
Catalog #: FTWW-PB-1T5H0-1C-120-S-WM-TS-4'
Efficiency: 68%
Test #: 12863.0

CANDLEPOWER DISTRIBUTION

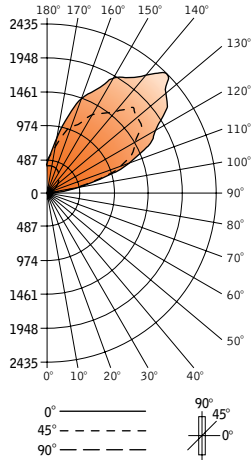

Vertical Angle	Horizontal Angle				Zonal Lumens
	0°	22.5°	45°	67.5°	
0°	51	51	51	51	51
5°	52	52	52	52	5
15°	57	55	53	53	15
25°	47	46	43	41	20
35°	44	38	34	32	22
45°	34	28	23	19	18
55°	21	15	12	10	11
65°	8	8	6	3	6
75°	1	1	1	1	1
85°	0	0	0	0	0
90°	0	0	0	0	0
95°	221	206	203	173	108
105°	846	818	804	627	392
115°	1634	1571	1371	858	617
125°	2100	1989	1673	903	665
135°	2431	2252	1742	907	630
145°	2012	1832	1382	760	431
155°	1603	1452	1105	660	271
165°	1043	961	774	548	134
175°	555	530	481	421	37
180°	375	375	375	375	375

LUMEN SUMMARY

Zone	Lumens	% Lamp	% Fixt
0°-30°	40	.8	1.2
0°-90°	98	2.0	2.9
90°-130°	1782	35.6	52.6
90°-180°	3286	65.7	97.1
Total Luminaire	0°-180° 3385	67.7	100.0