

4.5" – led wall wash
id® with emergency battery

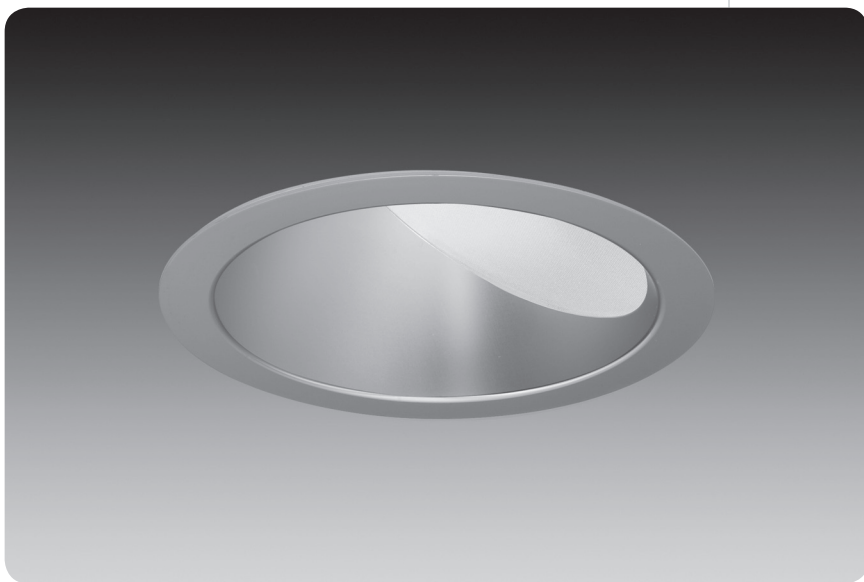

features

LED module features remote phosphor technology enabling a high system efficacy and minimum 80 CRI.

Battery pack delivers emergency light levels and is compatible with all available LED modules. Remote test switch available.

Future-proof LED system design maintains form factor, lumen output, and thermal characteristics of module and driver as technology advances, allows for easy replacement and upgrades.

Rated life is 50,000 hours at 70% lumen maintenance (L70).

Flicker-free 0-10V analog dimming capability standard.

LED module tilted to deliver excellent wall wash performance.

reflector options

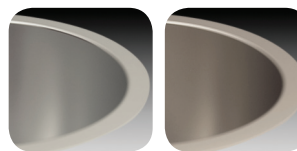

clear diffuse

warm diffuse

dimensional data

remote test switch (emr)–above ceiling access

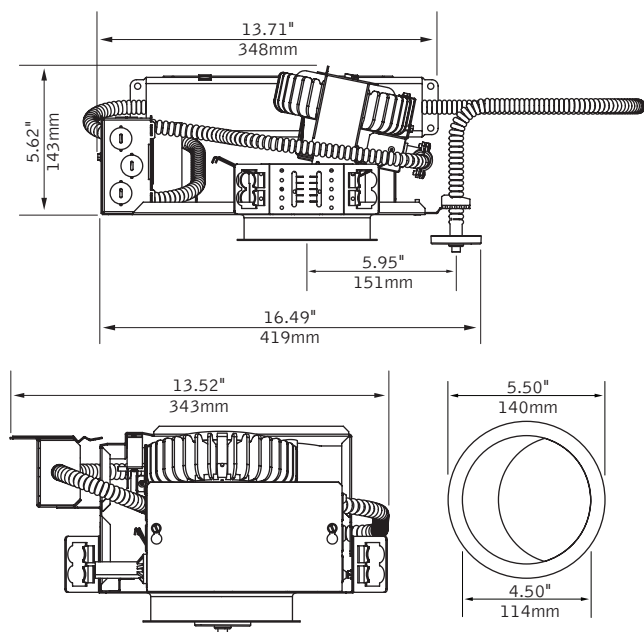

performance

23W, 3500K, 1300 Lumen LED Module
 Clear Diffuse Reflector
 Total Luminaire Output: 625lms
 Photometric performance is measured in accordance with IESNA LM-79.



Use 1300 lumen LED downlight in place of a 6" 32W compact fluorescent

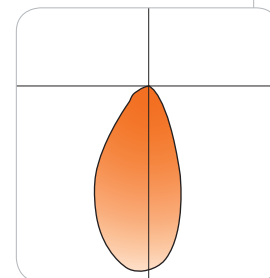

Visit focalpointlights.com for complete photometric data.

fixture:

project:

housing orientation to wall

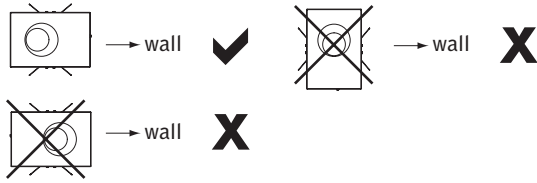

housing specifications

led system

Powered by Philips' Fortimo™ LED DLM, Advance Xitanium LED driver and communication cable. Aluminum heat sink provides appropriate thermal management. System is future-proof, allowing for easy replacement and upgrades as LED technology advances.

led module

Philips' Fortimo™ LED DLM features patented remote phosphor technology for superior efficacy and color consistency. Module may be specified in 3000K, 3500K or 4000K, CRI>80.

construction

Thermally protected housing for new construction applications. Insulation to be kept 3" away from housing. Butterfly brackets allow mounting to ½ emt. Order bar hangers as an accessory. Die-cast aluminum heat sink designed for maximum thermal dissipation. Die-formed housing and integral junction box with (7) 1/2" pry outs. Accommodates ceiling thicknesses up to 1". For thicker ceiling consult factory. Fixture will not exceed 5 lb.

electrical

Advance Xitanium multi-volt 120V-277V constant current driver includes standard 0-10V analog dimming. Power factor >.9 typical, 50/60Hz., 200-700mA, input power range, 17-23.5w. "Thermal Guard" offers protection from overheating in abnormal conditions; driver will dim DLM if necessary. Voltage specific thermal protectors included standard.

emergency battery

Bodine BSL17C-C2.

Emergency output—660 module lumens for all available models.

Color Temp	Rated System Watts	Delivered Lumens	Lumens/Watts	Color Temp	Rated System Watts	Delivered Lumens	Lumens/Watts
1100 Lumen Module				1300 Lumen Module			
3000K	19.0	533	28.1	3000K	23.5	625	26.6
3500K	18.0	533	29.6	3500K	23.0	625	27.2
4000K	17.0	533	31.4	4000K	21.0	625	29.8

*Lumen rating based on Clear Diffuse reflector cone

*Lumen output may vary +/- 5%

*Actual wattage may vary +/- 5%

*Module output is identical for all available color temperatures.

dimming

0-10V DC low voltage dimming capability is included with the standard Advance Xitanium driver. Dimming range is to 10% light output, some dimmers may require high and/or low end trim adjustment for proper function. Consult the [ID LED Technical Guide](#) for compatible dimmers and control systems.

labels

UL and cUL Listed. Lensed trims suitable for Wet Location.

lifetime & warranty

LED System rated for 50,000 hours at 70% lumen output (L70). Rated life and lumen output based on maximum temperature of 65°C at Tc point on LED module. If Tc temperature rises above rated maximum due to end use conditions, lifetime and lumen output may decrease. 5 year limited warranty on LED system provided by Philips.

trim specifications

aesthetics

Parabolic reflector cone ensures glare free optics. Reflector is .050 spun aluminum. Torsion springs pull trim tight to the ceiling with no visible fasteners within the trim.

Overlap trims are self-flanged, non-painted to match reflector finish. White painted flange may also be specified.

optics

Wall wash features high reflectance white kicker reflector and C73 Prismatic tempered glass diffuser to provide smooth illumination down the wall.

housing ordering

housing series	FL4W
ID LED Round	FL4W
led module	
1100 Lumen LED Module	11LED
1300 Lumen LED Module	13LED
color temperature	
3000K	L30
3500K	L35
4000K	L40
voltage	
120V	120
277V	277
trim type	RO
Round Overlap	RO
housing type	T
Thermally Protected, Non-IC	T
factory options	
Emergency Battery Pack with Remote Test Switch	EMR

trim ordering

aperture	L4
4.5" Round Reflector	L4
trim type	RO
Round Overlap	RO
optic	WW
Lensed Wall Wash (wet location)	WW
color	
Clear Diffuse	CD
Warm Diffuse	WD
flange finish	
Non-Painted	NP
White Painted	WP

a complete unit consists of two line items, housing and trim

example:

FL4W-13LED-L30-120-RO-T_EM
L4-RO-WW-CD-NP



id led—emergency battery ordering

4.5" Round

	Integral Test Switch		Remote Test Switch	
	Housing	Trim	Housing	Trim
Downlight (DN)	EM	L4EM (Truncated Reflector)	EMR	L4
Downlight w/Regress Lens (RL)	XX	XX	EMR	L4
Wall Wash (WW)	XX	XX	EMR	L4

4.5" × 4.5" Square

	Integral Test Switch		Remote Test Switch	
	Housing	Trim	Housing	Trim
Downlight (DN)	EM	L44EM (Open Reflector)	EMR	L44
Downlight w/Regress Lens (RL)	EM	L44EM (Open Reflector)	EMR	L44
Wall Wash (WW)	EM	L44	EMR	L44
Decorative Lens	EM	L44	EMR	L44

6" Round

	Integral Test Switch		Remote Test Switch	
	Housing	Trim	Housing	Trim
Downlight (DN)	EM	L6EM (Accommodates Test Switch)	EMR	L6
Downlight w/Regress Lens (RL)	EM	L6EM (Accommodates Test Switch)	EMR	L6
Wall Wash (WW)	EM	L6	EMR	L6

4.5" – led wall wash
1300 lumen, 3500 K
id®

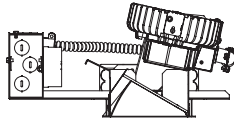

Filename: FL4WWWCD13LEDL35.IES
Catalog #: FL4DW-13LED-L35-RW-T, L4-R0-DN-CD
Photometric Report #: 27116

footcandle values - example

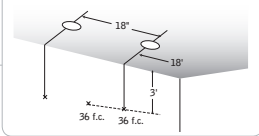

CANDLEPOWER DISTRIBUTION

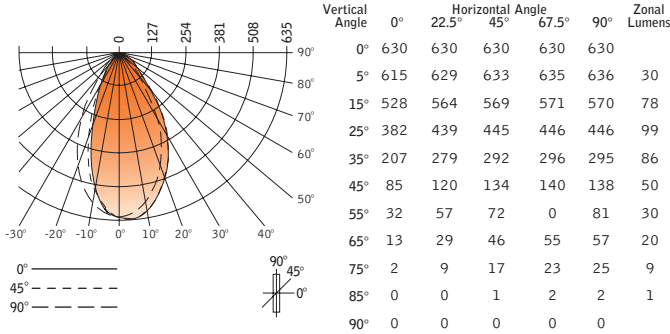

FOOTCANDLE VALUES - units 24" from the wall

distance from ceiling	18"			24"			30"			36"		
1'	19	20	19	15	15	15	13	11	13	12	8	12
2'	24	25	24	20	19	20	17	14	17	15	11	15
3'	29	30	29	23	24	23	19	19	19	17	15	17
4'	25	25	25	20	20	20	17	17	17	14	14	14
5'	18	19	18	15	16	15	13	13	13	11	11	11
6'	13	14	13	12	12	12	10	10	10	9	9	9
7'	10	10	10	9	9	9	8	8	8	7	7	7
8'	7	7	7	6	7	6	6	6	6	5	5	5
9'	5	5	5	5	5	5	5	5	5	4	4	4
10'	4	4	4	4	4	4	4	4	4	3	3	3

FOOTCANDLE VALUES - units 18" from the wall

distance from ceiling	18"			24"			30"			36"		
1'	31	31	31	25	22	25	22	16	22	21	11	21
2'	40	41	40	33	29	33	29	21	29	28	15	28
3'	36	36	36	28	28	28	23	23	23	20	18	20
4'	25	26	25	20	20	20	17	17	17	14	14	14
5'	17	17	17	14	14	14	12	12	12	10	10	10
6'	12	12	12	10	10	10	9	9	9	7	7	7
7'	8	8	8	7	7	7	6	6	6	6	6	6
8'	6	6	6	5	5	5	5	5	5	4	4	4
9'	4	4	4	4	4	4	4	4	4	3	3	3
10'	3	3	3	3	3	3	3	3	3	3	3	3

FOOTCANDLE VALUES - units 30" from the wall

distance from ceiling	18"			24"			30"			36"		
1'	12	12	12	9	10	9	8	7	8	21	11	21
2'	17	18	17	14	14	14	12	11	12	28	15	28
3'	21	21	21	17	17	17	14	14	14	20	18	20
4'	22	22	22	18	18	18	15	15	15	14	14	14
5'	18	19	18	15	16	15	13	13	13	10	10	10
6'	14	14	14	12	12	12	10	11	10	7	7	7
7'	11	11	11	9	10	9	8	9	8	6	6	6
8'	8	8	8	7	8	7	7	7	7	4	4	4
9'	6	6	6	6	6	6	5	5	5	3	3	3
10'	5	5	5	5	5	5	4	4	4	3	3	3

Footcandle results based on AG132; with microprismatic lens; Reflectances=0/0/0; LLF=1

4.5" – led wall wash
1100 lumen, 3500 K
id®

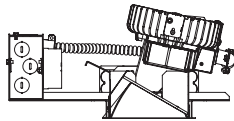

Filename: FL4WWWCD11LEDL35.IES
Catalog #: FL4DW-11LED-L35-RW-T, L4-R0-DN-CD
Photometric Report #: 27115

footcandle values - example

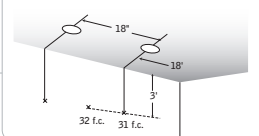

CANDLEPOWER DISTRIBUTION

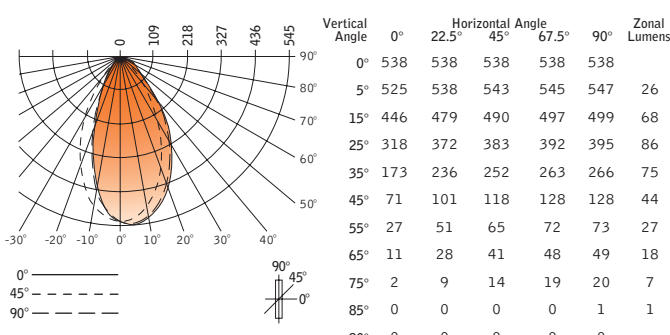

FOOTCANDLE VALUES - units 24" from the wall

distance from ceiling	18"			24"			30"			36"		
1'	17	17	17	13	13	13	11	10	11	10	7	10
2'	22	23	22	18	17	18	16	13	16	14	10	14
3'	26	27	26	21	21	21	17	17	17	15	13	15
4'	22	22	22	18	18	18	15	15	15	12	12	12
5'	16	17	16	13	14	13	11	11	11	10	10	10
6'	12	12	12	10	10	10	9	9	9	8	8	8
7'	8	9	8	7	8	7	7	7	7	6	6	6
8'	6	6	6	6	6	6	5	5	5	4	5	4
9'	5	5	5	4	4	4	4	4	4	4	4	4
10'	4	4	4	3	3	3	3	3	3	3	3	3

FOOTCANDLE VALUES - units 18" from the wall

distance from ceiling	18"			24"			30"			36"		
1'	28	27	28	22	19	22	20	14	20	19	10	19
2'	36	37	36	30	26	30	27	18	27	25	13	25
3'	31	32	31	24	25	24	20	20	20	18	16	18
4'	22	22	22	18	18	18	14	14	14	12	12	12
5'	15	15	15	12	12	12	10	10	10	9	9	9
6'	10	10	10	9	9	9	7	8	7	6	6	6
7'	7	7	7	6	6	6	5	6	5	5	5	5
8'	5	5	5	5	5	5	4	4	4	4	4	4
9'	4	4	4	3	3	3	3	3	3	3	3	3
10'	3	3	3	3	3	3	2	2	2	2	2	2

FOOTCANDLE VALUES - units 30" from the wall

distance from ceiling	18"			24"			30"			36"		
1'	10	10	10	8	8	8	7	6	7	19	10	19
2'	16	16	16	13	13	13	11	10	11	25	13	25
3'	19	19	19	15	15	15	13	12	13	18	16	18
4'	19	20	19	16	16	16	13	13	13	12	12	12
5'	16	16	16	13	14	13	11	11	11	9	9	9
6'	12	12	12	11	11	11	9	9	9	6	6	6
7'	9	9	9	8	8	8	7	7	7	5	5	5
8'	7	7	7	6	7	6	6	6	6	4	4	4
9'	5	5	5	5	5	5	5	5	5	3	3	3
10'	4	4	4	4	4	4	4	4	4	2	2	2

Footcandle results based on AG132; with microprismatic lens; Reflectances=0/0/0; LLF=1