

avenue® 6 + i.d.™

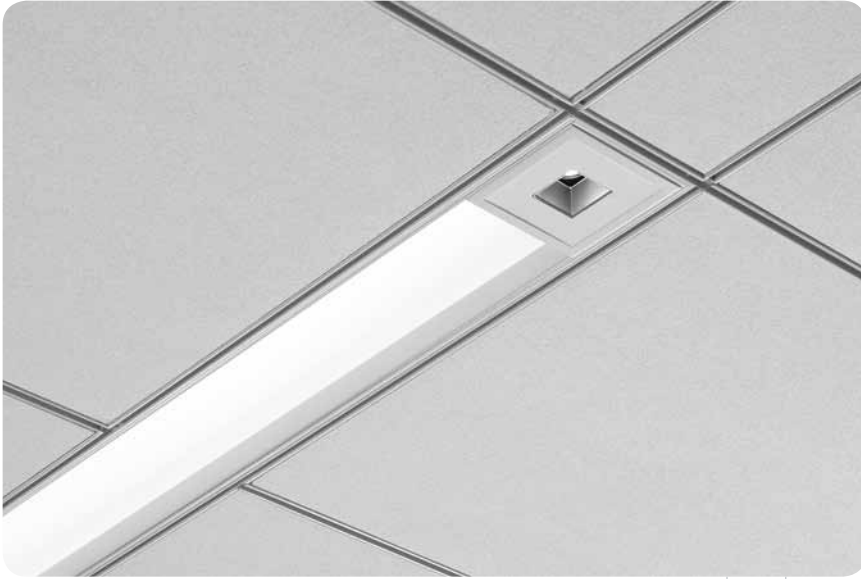

features

Avenue® 6 is designed to function with other 6" ceiling systems, standard grid or drywall.

1 and 2 lamp energy efficient fluorescent T5/T5HO or T8 combined with (2) 50 watt MR16 modules.

Fluorescent shielding options include corrugated or solid regressed trim, flush lens or parabolic louver.

shielding options

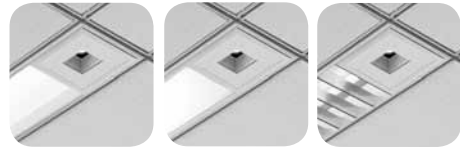

solid regressed trim

flush lens

parabolic louver

mr16 options



id mr16

flush mount mr16

id mr16 reflector options

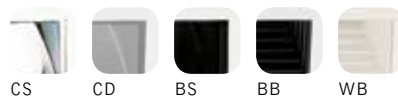

CS

CD

BS

BB

WB

companion luminaire



recessed

suspended

twelve with MicroGlow™

dimensional data

grid mount

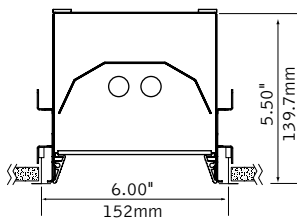

downlight

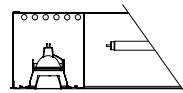

adjustable accent

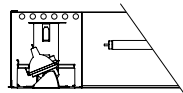

drywall flange

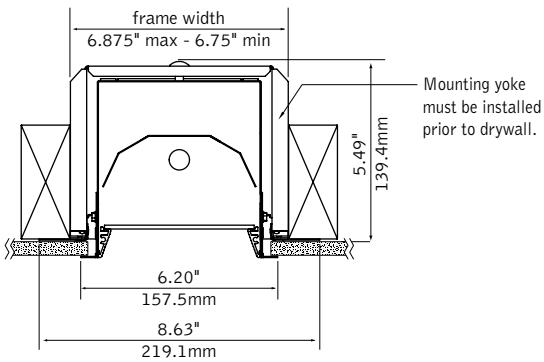

lamping/shielding options

regressed trim

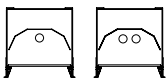

flush lens

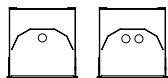

parabolic louver

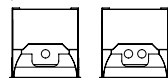

performance

1-Lamp T5HO
67% Efficiency
1392 cd @ 125°

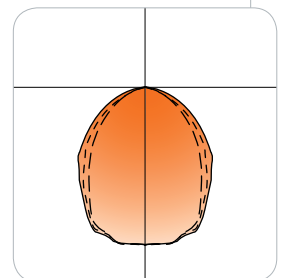

Visit focalpointlights.com for complete photometric data.

fixture:

project:

mounting information

grid

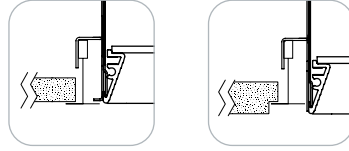
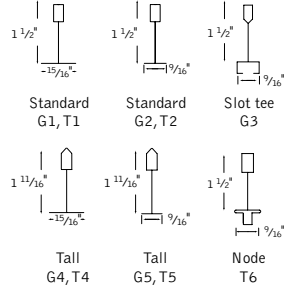

lay-in tile tegular tile

Luminaire always rests at level of tile.

drywall

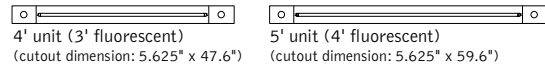

specifications

construction

One-piece 20 Ga. steel housing
Corrugated and solid regress trim constructed of 6063-T5 extruded aluminum finished in Matte Satin White.
20 Ga. steel, universal flange rail finished in Matte Satin White.
Housing includes thermally protected (50W max), (T-rated) MR16 modules.
Die-cast trim is keyed to housing during relamping via swing clear torsion springs.
Torsion springs pull up tight to the ceiling and install in 90° increments.
No visible fasteners within the trim.
Mechanical light traps eliminate light leaks.
Earthquake brackets supplied as standard.

4' unit weight: 18 lbs.
5' unit weight: 25 lbs.

optic

22 Ga. steel reflectors finished in High Reflectance White powder coat.
Acrylic lens diffuser .118" thick, frosted clear.
Parabolic louver: .75"H x 1.5" frequency fabricated of low iridescent, semi-specular premium grade aluminum.
Louver can be specified with matte white finish.
MR16 optics provide 50° cutoff to the lamp and lamp image.
Die-cast parabolic cone ensures glare free optics.
Clear Specular "CS", Clear Diffuse "CD", Black Specular "BS", Black Baffle "BB" and White Baffle "WB" are painted finishes.

adjustment mechanism

Auto Memory for relamping, lamp returns to preset aiming position.
Mechanism is stainless steel with, matte black finish, and holds lamp and lenses independently. Hot aiming with Philips screwdriver allows for 363° rotation and 0-45° vertical tilt when Adjustable Accent "AA" is specified. Hand and trim rotate with the lamp so as not to block the beam of light. Mechanism pulls down from recessed housing for quick and easy relamping.
Vertical angle and horizontal rotation indicators display positioning.
Tempered soft focus lens supplied as standard.
Lens tray can hold up to three accessories, up to 3/8" thick. Lenses remain undisturbed during relamping.

electrical

Luminaires are individually wired for specified circuits.
Thru-wiring not available.
Electronic ballasts are thermally protected and have a Class "P" rating.
Porcelain bi pin socket with #18 Teflon leads with keyed quick connection.
Thermally protected, guards against overheating and misuse of insulation.
Transformers available in 120V or 277V electronic.
Consult factory for dimming specifications and availability.
UL and cUL listed.

finish

Polyester powder coat applied over a 5-stage pre-treatment.

ordering

luminaire series		FAV6
Avenue 6	FAV6	
shielding		
Corrugated Regressed Trim Frst.Lns	CR	
Solid Regressed Trim Frosted Lens	SR	
Flush Frosted Lens	FL	
Parabolic Louver (T5/T5H0 only)	PL	
White Painted Parabolic Louver (T5/T5H0 only)	PW	
Corrugated Regressed Trim with MicroGlow™ Lens	CRM	
Solid Regressed Trim with MicroGlow™ Lens	SRM	
Flush MicroGlow™ Lens	FLM	
lampping		
One Lamp T5	1T5	
One Lamp T5H0	1T5H0	
One Lamp T8	1T8	
Two Lamp T5	2T5	
Two Lamp T5H0	2T5H0	
Two Lamp T8	2T8	
circuits		
Dual Circuit (fluor. switched separately from incandescent)	2C	
Three Circuit (Circ. 1 & Circ. 2 Fluor./Circ. 3 Incandescent)	3C	
voltage		
120 Volt	120	
277 Volt	277	
ballast		
Electronic Program Start <10% THD	S	
Electronic Dimming Ballast*	D	
ceiling configurations		
Drywall Flange	F	
Std. 15/16" Lay-in	G1	
Std. 15/16" Tegular	T1	
Std. 9/16" Lay-in	G2	
Std. 9/16" Tegular	T2	
9/16" Slot-tee Tegular	G3	
Tall 15/16" Lay-in	G4	
Tall 15/16" Tegular	T4	
Tall 9/16" Lay-in	G5	
Tall 9/16" Tegular	T5	
Node 9/16" Tegular	T6	
mr16		
Fixed Downlight	DNF	
0-45° Adjustable Accent	AA	
Flush Mount	2FM	
reflector color		
Clear Specular	CS	
Clear Diffuse	CD	
Black Specular	BS	
Black Baffle	BB	
White Baffle	WB	
(Baffle available for downlight only)		
lens accessories		
Hex Louver	HL	
Linear Spread Lens	LSL	
Prismatic Spread Lens	PSL	
Sand Blasted Lens	SBL	
Clear Lens	CL	
UV Lens	UVL	
factory options		
Chicago Plenum	CP	
Emergency Battery Pack* (4' Luminaires Only. Not available on 3 Cir.)	EM	
HLR/GLR Fuse	FU	
Include 3000K Lamp*	L830	
Include 3500K Lamp*	L835	
Include 4100K Lamp*	L841	
Lutron™ Sensor Feed* (EcoSystem ballast required)	SF	
finish		<u>WH</u>
Matte White Housing & Trim Plate	WH	
luminaire length		
4' Nominal Housing	4'	
5' Nominal Housing	5'	

* for more information see Reference section.

avenue® 6

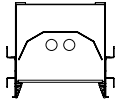

Filename: FAV6SR1T5H.IES
 Catalog #: FAV6-SR-1T5H0-1C-120-S-G1-WH-4'
 Efficiency: 67%
 Test #: 13928.0

CANDLEPOWER DISTRIBUTION

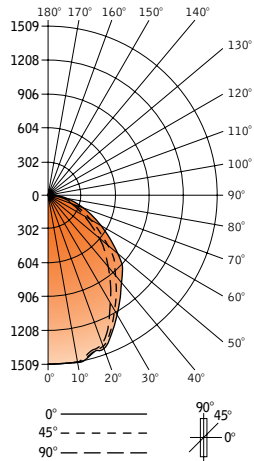

Spacing 1.2
 Criterion: 1.1

Vertical Angle	Horizontal Angle				Zonal Lumens
	0°	22.5°	45°	67.5°	
0°	1499	1499	1499	1499	1499
5°	1499	1499	1499	1497	1497
15°	1452	1449	1442	1435	1432
25°	1324	1316	1292	1265	1248
35°	1096	1082	1030	965	938
45°	911	889	798	713	684
55°	637	603	513	451	429
65°	400	363	294	257	247
75°	190	16	129	113	109
85°	42	31	22	21	19
90°	0	0	0	0	0
95°	0	0	0	0	0
105°	0	0	0	0	0
115°	0	0	0	0	0
125°	0	0	0	0	0
135°	0	0	0	0	0
145°	0	0	0	0	0
155°	0	0	0	0	0
165°	0	0	0	0	0
175°	0	0	0	0	0
180°	0	0	0	0	0

LUMEN SUMMARY

Zone	Lumens	% Lamp	% Fixt
0°-30°	1149	23.0	34.2
0°-40°	1792	35.8	53.3
0°-60°	2882	57.6	84.7
0°-90°	3364	67.3	100
Total Luminaire	0°-180° 3364	67.3	100

LUMINANCE DATA (CD/M²)

Vertical Angle	0°	45°	90°
45°	8876	7775	6665
55°	7652	6162	5153
65°	6521	4793	4027
75°	5058	3434	2902
85°	3320	1739	1502

CO-EFFICIENTS OF UTILIZATION

Floor	80	70	20	50	30	10	00
Ceiling	70	50	30	10	70	50	10
Wall	80	80	80	80	78	78	78
RCR 0	80	80	80	80	78	78	78
1	75	72	69	67	73	70	66
2	69	61	60	57	67	63	56
3	64	58	53	49	62	58	49
4	59	52	47	43	57	51	42
5	54	46	41	37	53	46	37
6	50	42	36	32	49	41	32
7	46	38	32	29	45	37	28
8	43	34	29	25	42	34	25
9	39	31	25	22	39	30	22
10	37	28	23	19	36	28	19

Go to www.focalpointlights.com for additional photometric data.

Numbers indicate percentage values of

avenue® 6

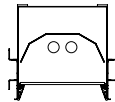

Filename: FAV6FL1T5H.IES
 Catalog #: FAV6-FL-1T5H0-1C-120-G1-WH-4'
 Efficiency: 67%
 Test #: 13929.0

CANDLEPOWER DISTRIBUTION

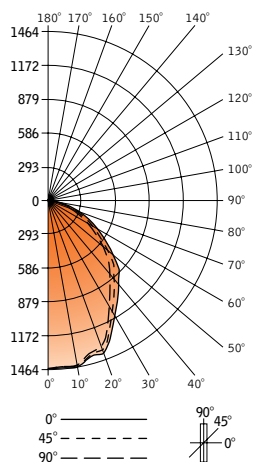

Spacing 1.2
 Criterion: 1.1

Vertical Angle	Horizontal Angle				Zonal Lumens
	0°	22.5°	45°	67.5°	
0°	1464	1464	1464	1464	1464
5°	1462	1460	1459	1457	1456
15°	1406	1402	1390	1380	1376
25°	1298	1268	1242	1211	1197
35°	1046	1029	985	942	925
45°	859	837	784	740	721
55°	592	572	532	498	486
65°	368	354	330	308	301
75°	175	170	158	150	146
85°	41	41	39	38	38
90°	0	0	0	0	0
95°	0	0	0	0	0
105°	0	0	0	0	0
115°	0	0	0	0	0
125°	0	0	0	0	0
135°	0	0	0	0	0
145°	0	0	0	0	0
155°	0	0	0	0	0
165°	0	0	0	0	0
175°	0	0	0	0	0
180°	0	0	0	0	0

LUMEN SUMMARY

Zone	Lumens	% Lamp	% Fixt
0°-30°	1107	22.1	33.0
0°-40°	1726	34.5	51.4
0°-60°	2817	56.3	83.9
0°-90°	3358	67.2	100
Total Luminaire	0°-180° 3358	67.2	100

LUMINANCE DATA (CD/M²)

Vertical Angle	0°	45°	90°
45°	8370	7639	7025
55°	7111	6390	5838
65°	5999	5380	4907
75°	4658	4206	3886
85°	3241	3083	3004

CO-EFFICIENTS OF UTILIZATION

Floor	80	70	20	50	30	10	00
Ceiling	70	50	30	10	70	50	10
Wall	80	80	80	80	78	78	78
RCR 0	80	80	80	80	78	78	78
1	74	71	69	67	72	70	66
2	68	64	60	56	67	62	56
3	63	57	50	48	62	56	48
4	58	51	46	42	57	50	41
5	53	46	40	36	52	45	36
6	49	41	35	31	48	40	31
7	46	37	32	28	45	37	28
8	42	33	28	4	41	33	24
9	39	30	25	21	38	30	21
10	36	27	22	19	35	27	19

Go to www.focalpointlights.com for additional photometric data.

Numbers indicate percentage values of

avenue® 6

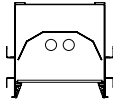

Filename: FAV6SR2T5H.IES
 Catalog #: FAV6-SR-2T5H0-1C-120-S-G1-WH-4'
 Efficiency: 53%
 Test #: 13926.0

CANDLEPOWER DISTRIBUTION

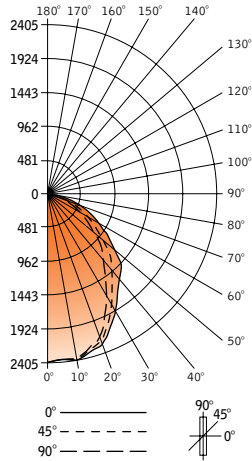

Vertical Angle	0°	22.5°	45°	67.5°	90°	Zonal Lumens
0°	2399	2399	2399	2399	2399	
5°	2377	2379	2374	2373	2370	227
15°	2326	2319	2299	2280	2270	652
25°	2090	2070	2016	1951	1917	930
35°	1727	1692	1584	1472	1426	993
45°	1466	1411	1244	1111	1063	974
55°	1023	958	806	705	674	744
65°	645	579	466	405	390	488
75°	298	252	201	176	168	228
85°	66	48	36	33	31	45
90°	0	0	0	0	0	0
95°	0	0	0	0	0	0
105°	0	0	0	0	0	0
115°	0	0	0	0	0	0
125°	0	0	0	0	0	0
135°	0	0	0	0	0	0
145°	0	0	0	0	0	0
155°	0	0	0	0	0	0
165°	0	0	0	0	0	0
175°	0	0	0	0	0	0
180°	0	0	0	0	0	0

Spacing 1.2
 Criterion: 1.1

LUMEN SUMMARY

Zone	Lumens	% Lamp	% Fixt
0°-30°	1809	18.1	34.2
0°-40°	202	28.0	53.1
0°-60°	4520	45.2	85.6
0°-90°	5281	52.8	100
Total Luminaire	0°-180°	5281	52.8 100

LUMINANCE DATA (CD/M²)

Vertical Angle	0°	45°	90°
45°	14284	12121	10357
55°	12288	9682	8096
65°	10515	7597	6358
75°	7922	5251	4472
85°	5217	2846	2451

CO-EFFICIENTS OF UTILIZATION

Floor	80	70	20	50	30	10	00
Wall	70 50 30 10	70 50 10	50 10	50 10	50 10	50 10	00
RCR 0	63 63 63 63	61 61 61	59 59	56 56	54 54	53	
1	59 56 55 53	57 55 52	53 50	51 49	49 47	46	
2	54 50 47 45	53 49 44	48 43	46 42	44 41	40	
3	50 45 42 39	49 44 38	43 38	42 37	40 36	35	
4	46 41 37 33	45 40 33	39 33	38 32	36 32	31	
5	42 36 32 29	41 36 29	35 28	34 28	33 28	27	
6	39 33 29 25	38 32 25	31 25	31 25	30 25	24	
7	36 30 25 22	35 29 22	28 22	28 22	27 22	21	
8	34 28 23 20	33 26 20	26 19	25 19	24 19	18	
9	31 24 20 19	30 24 17	23 17	23 17	22 17	16	
10	29 22 18 15	28 22 15	21 15	21 15	20 15	14	

Numbers indicate percentage values of

Go to www.focalpointlights.com for additional photometric data.

avenue® 6

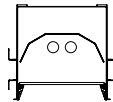

Filename: FAV6FL2T5H.IES
 Catalog #: FAV6-FL-2T5H0-1C-120-G1-WH-4'
 Efficiency: 53%
 Test #: 13927.0

CANDLEPOWER DISTRIBUTION

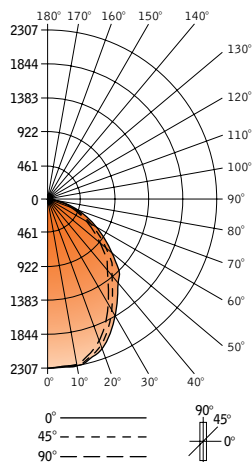

Vertical Angle	0°	22.5°	45°	67.5°	90°	Zonal Lumens
0°	2307	2307	2307	2307	2307	
5°	2291	2290	2287	2284	2281	218
15°	2245	2235	2213	2190	2179	627
25°	1999	1977	1919	1865	1841	889
35°	1641	1606	1523	1447	1416	959
45°	1367	1322	1223	1145	1117	955
55°	949	911	834	780	759	758
65°	591	565	515	484	473	520
75°	274	265	245	230	226	262
85°	65	63	61	61	61	68
90°	0	0	0	0	0	0
95°	0	0	0	0	0	0
105°	0	0	0	0	0	0
115°	0	0	0	0	0	0
125°	0	0	0	0	0	0
135°	0	0	0	0	0	0
145°	0	0	0	0	0	0
155°	0	0	0	0	0	0
165°	0	0	0	0	0	0
175°	0	0	0	0	0	0
180°	0	0	0	0	0	0

Spacing 1.2
 Criterion: 1.1

LUMEN SUMMARY

Zone	Lumens	% Lamp	% Fixt
0°-30°	1734	17.3	33.0
0°-40°	2693	26.9	51.2
0°-60°	4406	44.1	83.8
0°-90°	5255	52.6	100
Total Luminaire	0°-180°	5255	52.6 100

LUMINANCE DATA (CD/M²)

Vertical Angle	0°	45°	90°
45°	13319	11916	10883
55°	11399	10018	9117
65°	9635	8395	7711
75°	7294	6522	6016
85°	5138	4822	4822

CO-EFFICIENTS OF UTILIZATION

Floor	80	70	20	50	30	10	00
Wall	70 50 30 10	70 50 10	50 10	50 10	50 10	50 10	00
RCR 0	63 63 63 63	61 61 61	59 59	56 56	54 54	53	
1	58 56 54 52	57 55 51	53 50	50 48	49 47	46	
2	54 50 47 44	52 49 43	47 42	45 42	44 41	40	
3	49 45 41 38	48 44 37	42 37	41 36	40 36	34	
4	46 40 35 33	44 39 32	38 32	37 32	36 31	30	
5	42 36 31 28	41 35 28	34 28	33 27	32 27	26	
6	39 32 28 25	38 32 25	31 24	30 24	29 24	23	
7	36 9 25 22	35 29 22	28 21	27 21	26 21	20	
8	33 26 22 19	32 26 19	25 19	24 19	24 19	18	
9	30 24 19 17	30 23 16	3 16	22 16	22 16	15	
10	28 21 17 15	28 21 15	21 15	20 15	20 14	14	

Numbers indicate percentage values of

Go to www.focalpointlights.com for additional photometric data.